

DBX-112 baby monitor

---



**1**

1x  → 1x  + 1x 

---

 → 1x  + 1x  + 2x  NiMH AAA 400mAh rechargeable\*

**2**

 ↔ min. 1 m ↔ 

 max. 50 m ↔ max. 300 m ↔ 

**3**

 → 



 →  \*\*



---

 →  → 

 →  →  \*\*

**4**

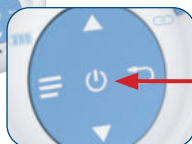
 →  ON / OFF  3sec

 →  ON / OFF  3sec

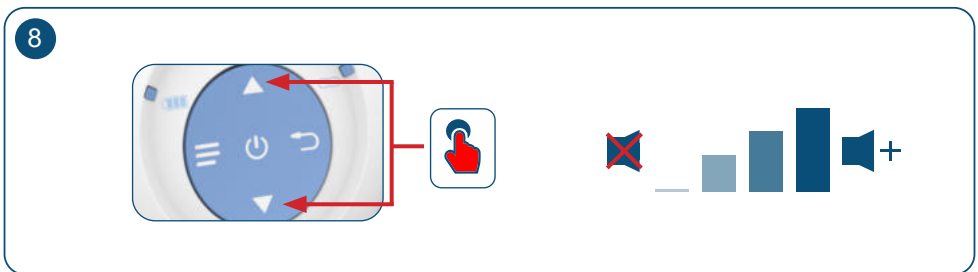
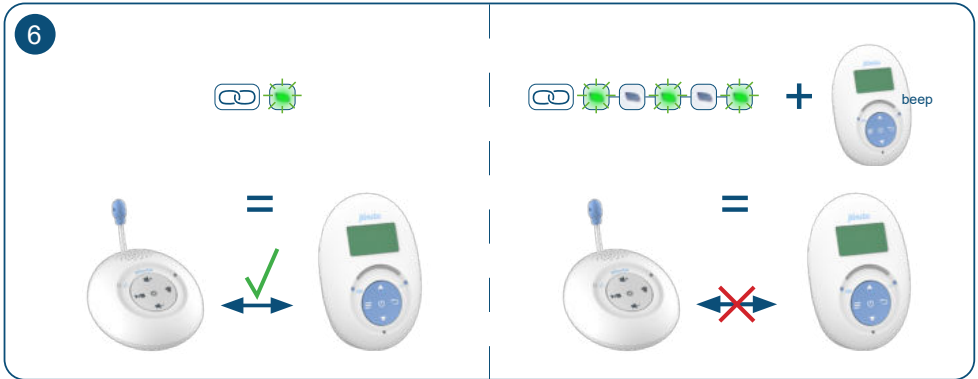
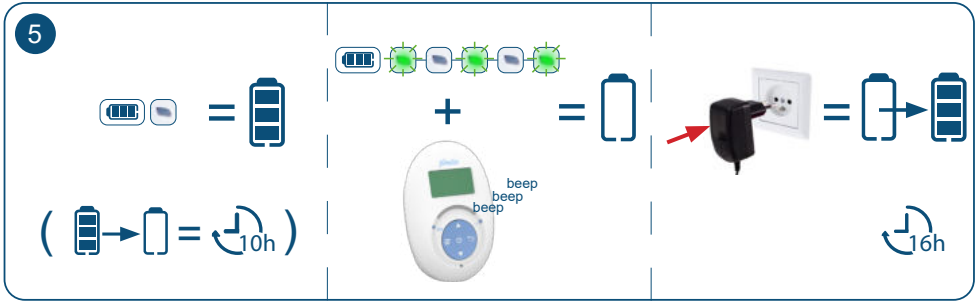

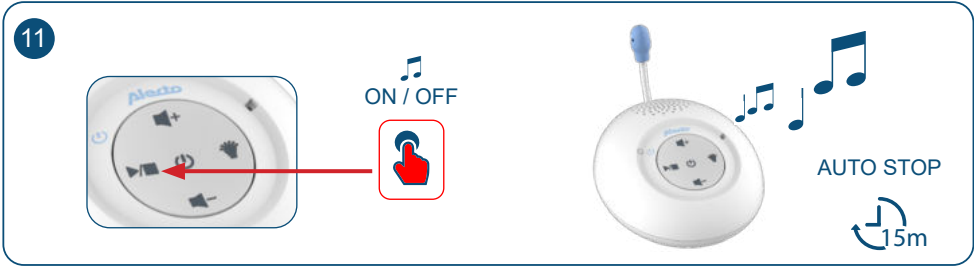
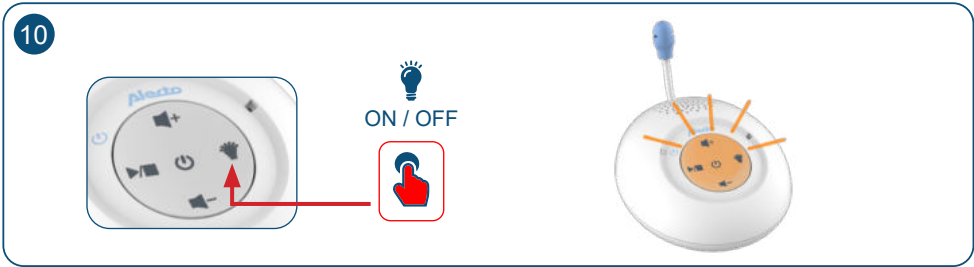
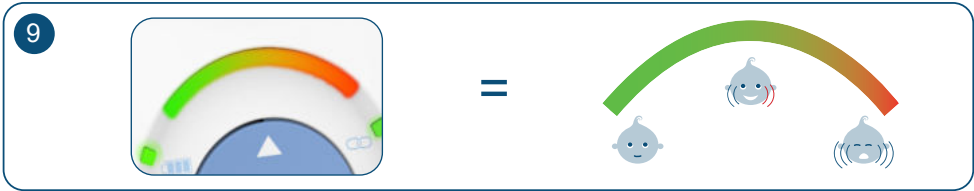

13 & 14 & 15

<b>NL</b> .....	6	<b>NO</b> .....	32
<b>FR</b> .....	8	<b>FI</b> .....	34
<b>DE</b> .....	10	<b>RU</b> .....	36
<b>GB</b> .....	12	<b>RS</b> .....	38
<b>ES</b> .....	14	<b>HR</b> .....	40
<b>IT</b> .....	16	<b>TR</b> .....	42
<b>PT</b> .....	18	<b>BG</b> .....	44
<b>PL</b> .....	20	<b>SK</b> .....	46
<b>RO</b> .....	22	<b>HU</b> .....	48
<b>GR</b> .....	24	<b>EE</b> .....	50
<b>CZ</b> .....	26	<b>LV</b> .....	52
<b>SE</b> .....	28	<b>SI</b> .....	54
<b>DK</b> .....	30	<b>UA</b> .....	56

### 13 Bediening van de toetsen

-  Menu toets / Bevestigingstoets (zie ook 15)
-  Omhoog in menu / Volume + (zie ook 8)
-  Omlaag in menu / Volume - (zie ook 8)
-  Terug naar vorige stap in het menu
-  In- en uitschakelen ouder-unit / Terug naar startscherm op display (zie ook 4)

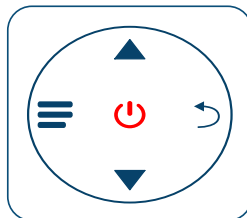



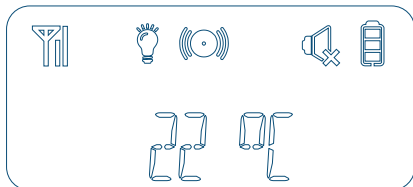





### 14 Startscherm ouder-unit



TE WARM = Temperatuuralarm baby-unit > 30 °C

TE KOUD = Temperatuuralarm baby-unit < 10 °C

- |  |  |   |
|--|--|---|
|  Geen verbinding met baby-unit      |  Geluidsalarm is aan            |  Batterij 2/3 vol    |
|  Goede verbinding met baby-unit     |  Geluid is uit op de ouder-unit |  Batterij 1/3 vol    |
|  Nachtlampje is aan op de baby-unit |  Batterij helemaal vol          |  Batterij bijna leeg |

### Uitleg bij 15

#### Gevoeligheid

Als de baby slaapt en geen geluid maakt is de Full Eco mode actief.

De baby-unit gaat dan naar standby en schakelt de zender uit, zodat er geen radio-verbinding meer is tussen de baby-unit en ouder-unit.

Wanneer de baby geluid maakt schakelt de zender weer in en is de baby weer te horen op de ouder-unit. De gevoeligheid hiervan is in 4 stappen in te stellen via de ▲▼ toetsen:

Stap 1 (minst gevoelig) tot stap 4 (meest gevoelig).

Bij stap 5 is de Full Eco mode uitgeschakeld en is er continu een verbinding.

#### Geluidsalarm



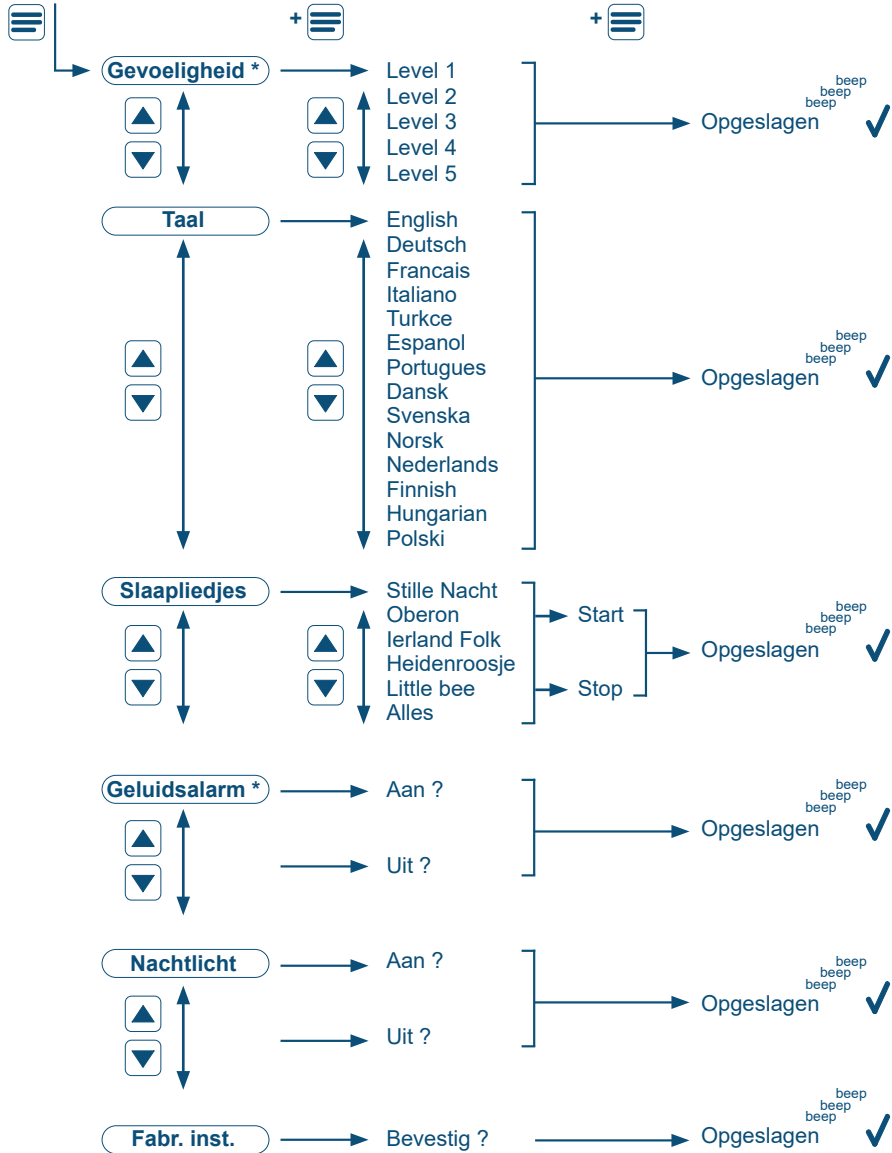

Indien de baby minimaal 3 seconden achter elkaar veel geluid maakt en het geluid van de ouder-unit staat op stil , gaat het licht van het display branden.

Tegelijkertijd gaat het geluidsalarm icoon  knipperen en komt er een geluidje uit de ouder-unit.

15 Menu



### 13 Fonctionnement des boutons

-  Bouton Menu / Bouton Confirmer (voir également 15)
-  Haut dans menu / Volume + (voir également 8)
-  Bas dans menu / Volume - (voir également 8)
-  Retour à l'étape précédente dans le menu
-  Unité parent marche et arrêt (voir également 4)  
Retour à l'écran de démarrage

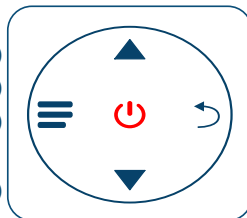



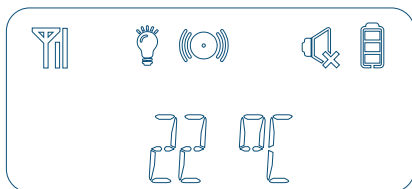





### 14 Ecran de démarrage de l'unité parent



HI TEMP = Alerte de température de l'unité bébé > 30 °C

LOW TEMP = Alerte de température de l'unité bébé < 10 °C

- |  |   |  |
|--|---|--|
|  Pas de connexion avec l'unité bébé |  L'alerte sonore est activée.      |  Batterie pleine au 2/3 |
|  Bonne connexion avec l'unité bébé  |  Le son de l'unité bébé est éteint |  Batterie pleine à 1/3  |
|  Veilleuse activée sur l'unité bébé |  Batterie pleinement chargée       |  Batterie Presque vide  |

### Explication sur 15

#### Sensibilité

Le mode Full Eco est actif lorsque le bébé est endormi et de fait pas de bruit.

L'unité bébé commutera alors en veille et l'émetteur est éteint, pour s'assurer qu'il n'y a plus de transfert entre l'unité bébé et l'unité parent.

Lorsque le bébé commence à faire du bruit, l'émetteur est activé de nouveau et vous pourrez entendre le bébé via l'unité parent. La sensibilité de cette fonction peut être réglée en 4 étapes en utilisant les boutons ▲▼ :

Etape 1 (sensibilité la plus faible) à étape 4 (sensibilité la plus forte).

A l'étape 4 le mode Full est éteint pour permettre une connexion continue.

#### Alerte son

Si le bébé fait beaucoup de bruit pendant au moins 3 secondes consécutives, et que le son de l'unité parent est réglé sur silence , le voyant de l'affichage s'éclaire.





Au même moment l'icône d'alerte sonore  commence à clignoter et l'unité parent émettra une tonalité.

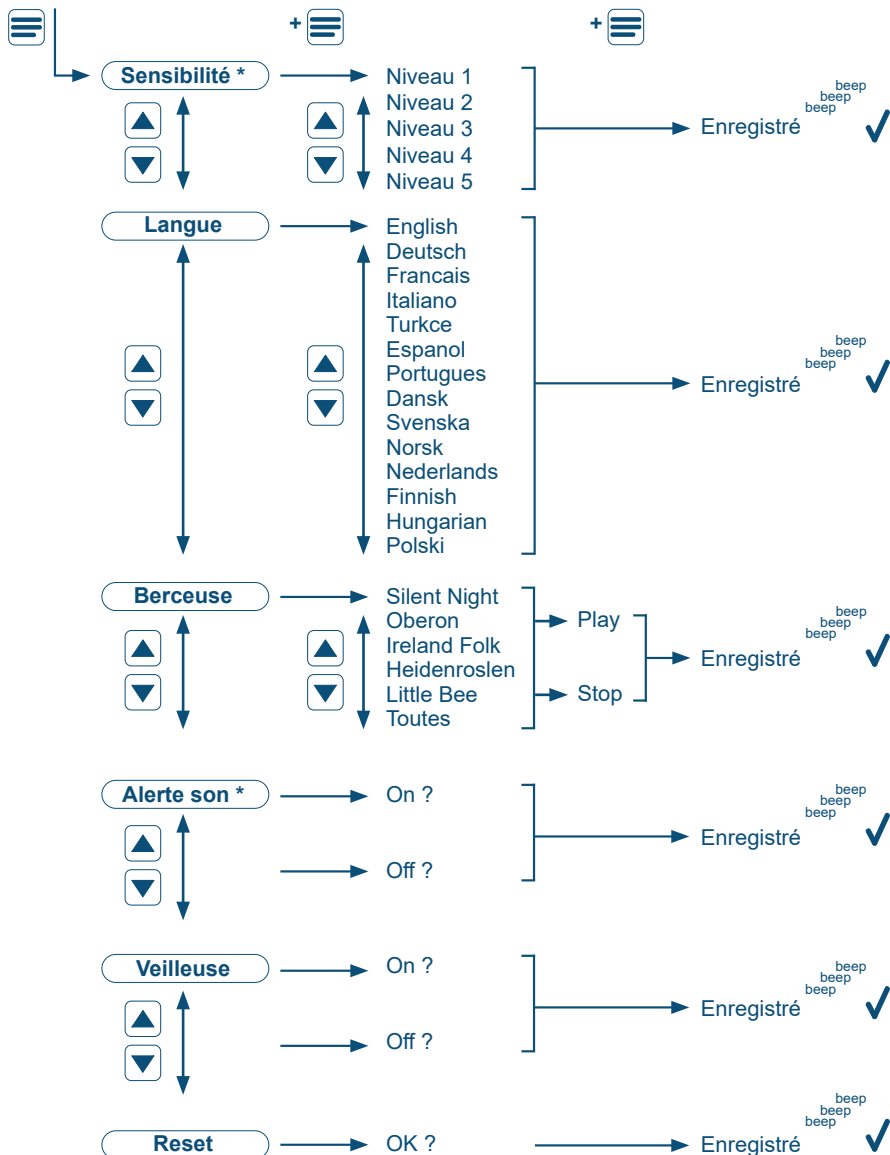

## 15 Menu



**13 Tastenbelegung**

-  Menüta<sup>ste</sup> / OK-Taste (siehe auch **15**)
-  Nach oben im Menü / Lautstärke + (siehe auch **8**)
-  Nach unten im Menü / Lautstärke - (siehe auch **8**)
-  Zum vorherigen Schritt im Menü zurückkehren
-  Elterneinheit ein- und ausschalten (siehe auch **4**)  
Zurück zum Startbildschirm am Display

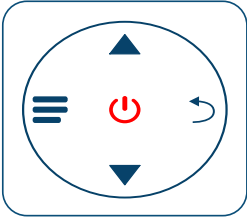

**14 Startbildschirm der Elterneinheit**

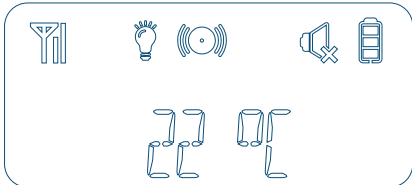

ZU WARM = Babyeinheit Temperaturalarm > 30 °C

ZU KALT= Babyeinheit Temperaturalarm < 10 °C

- |   |  |  |
|---|--|--|
|  Keine Verbindung mit der Babyeinheit                      |  Tonalarm ist deaktiviert                 |  Akku 2/3 voll  |
|  Gute Verbindung mit der Babyeinheit                       |  Ton an der Babyeinheit ist ausgeschaltet |  Akku 1/3 voll  |
|  Nachtl <sup>icht</sup> an der Babyeinheit ist deaktiviert |  Akku vollständig aufgeladen              |  Akku fast leer |

**Erklärung auf **15****

**Sensitivität**

Der Full Eco-Modus ist aktiviert, wenn das Baby schläft und leise ist. Die Babyeinheit schaltet dann auf Standby und der Sender ist ausgeschaltet, um sicherzustellen, dass zwischen Baby- und Elterneinheit keine Übertragung stattfindet. Wenn das Baby laut wird, wird der Sender wieder aktiviert und Sie können das Baby auf der Elterneinheit hören. Die Sensitivität dieser Funktion kann mit den ▲ ▼ - Tasten in vier Schritten eingestellt werden: Schritt 1 (niedrigste Sensitivität) bis Schritt 4 (höchste Sensitivität). Bei Schritt 4 wird der Full Eco-Modus für eine durchgehende Verbindung ausgeschaltet.



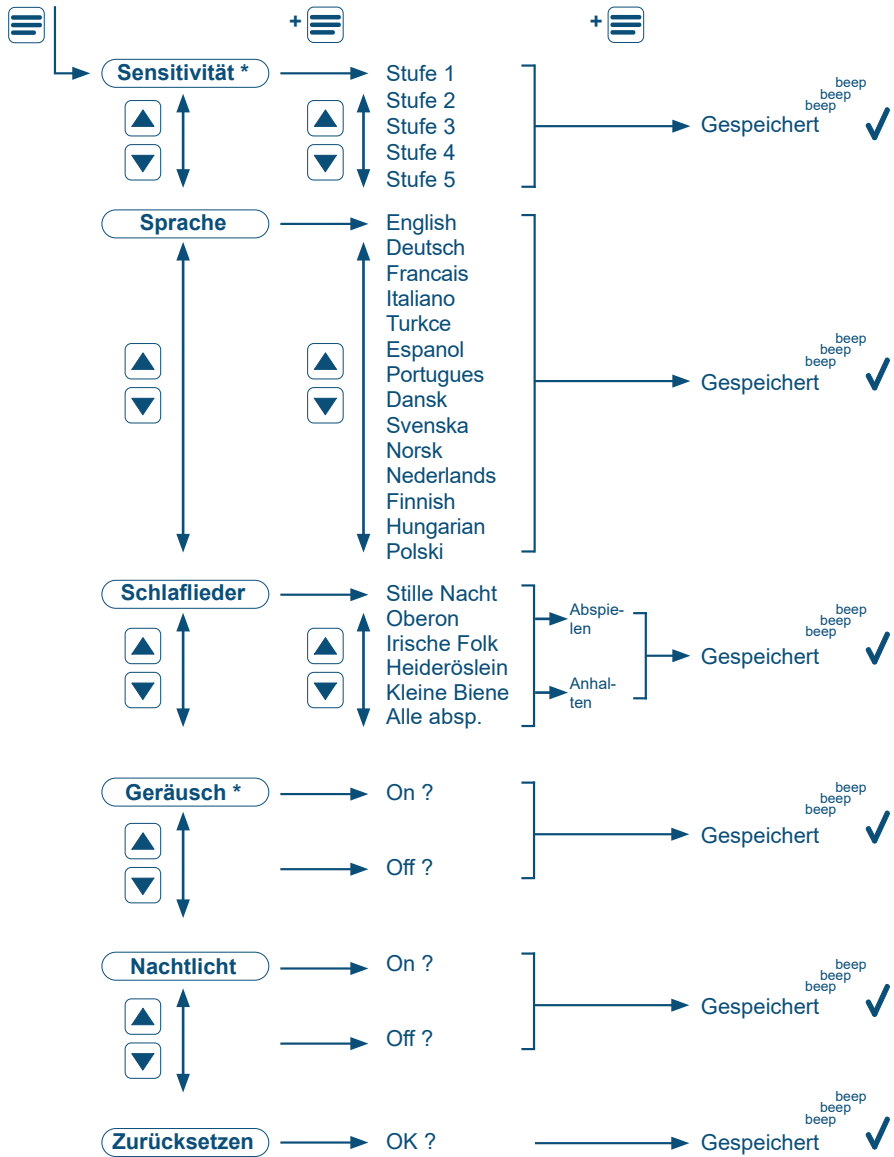

**Geräusch**

Wenn das Baby für mindestens 3 nachfolgende Sekunden sehr laut ist und der Ton der Elterneinheit auf Leise  eingestellt ist, leuchtet das Licht am Display auf. Gleichzeitig fängt das Tonalarmsymbol  an zu blinken und die Elterneinheit gibt einen Ton aus.

15 Menü



### 13 Buttons operation

-  Menu button / Confirm button (see also 15)
-  Up in menu / Volume + (see also 8)
-  Down in menu / Volume - (see also 8)
-  Return to the previous step in the menu
-  Parent unit on and off (see also 4)  
Back to the display's start-up screen

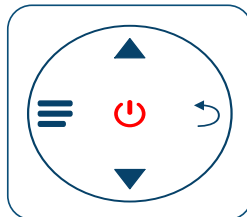



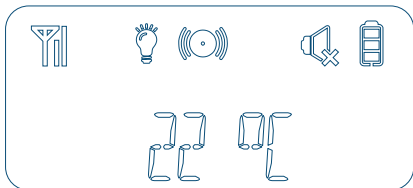





### 14 Parent unit start-up screen



HI TEMP = Baby unit temperature alert > 30 °C

LO TEMP = Baby unit temperature alert < 10 °C

- |   |   |  |
|---|---|--|
|  No connection with baby unit            |  Sound alert is enabled          |  Battery 2/3 full     |
|  Good connection with baby unit          |  Sound on the parent unit is off |  Battery 1/3 full     |
|  Night light is enabled on the baby unit |  Battery fully charged           |  Battery nearly empty |

### Explanation at 15

#### Sensitivity

The Full Eco mode is active when the baby is sleeping and making no sounds.

The baby unit will then switch to standby and the transmitter is turned off, to ensure that there's no more transfer between the baby unit and parent unit.

When the baby starts making sounds, the transmitter is enabled again and you'll be able to hear the baby through the parent unit. The sensitivity of this function may be set in 4 steps using the ▲ ▼ buttons:

Step 1 (lowest sensitivity) to step 4 (highest sensitivity).

At step 4 the Full Eco mode is switched off to allow for a continuous connection.

#### Sound alert



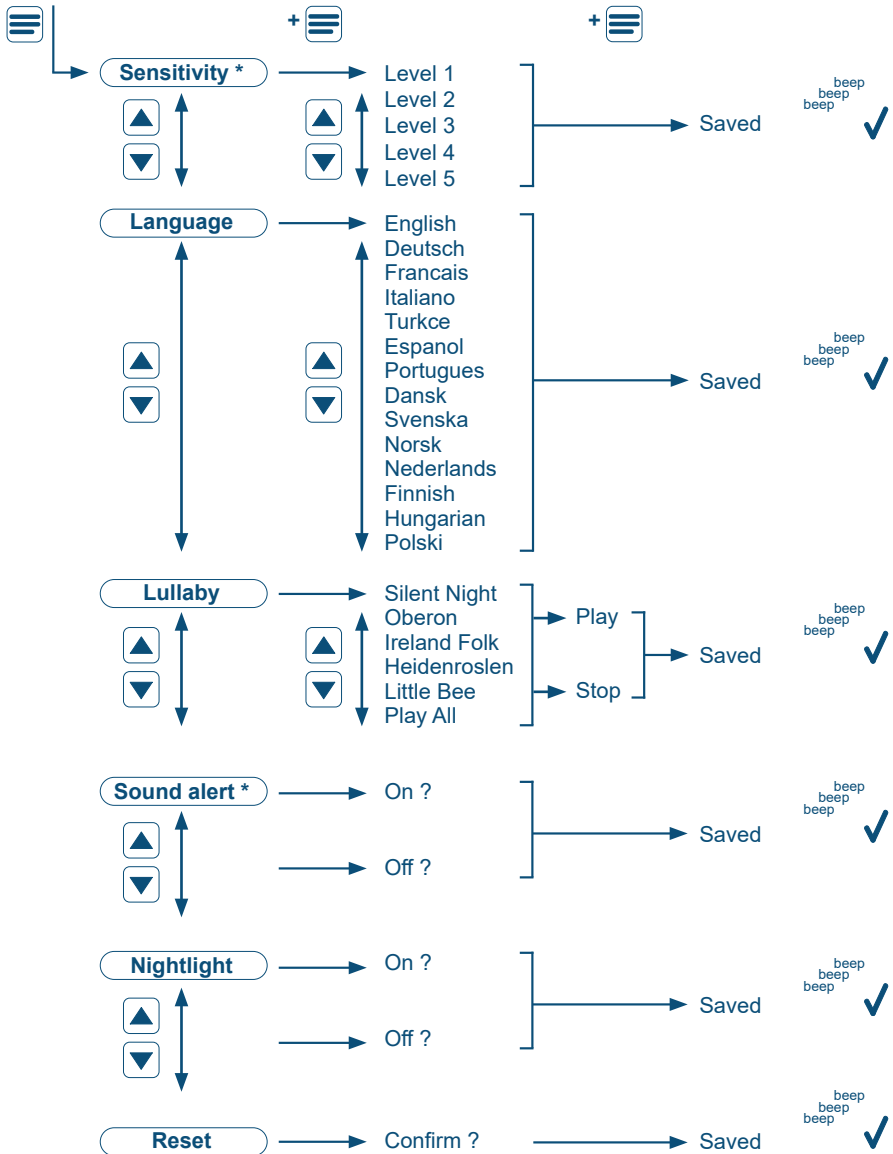

If the baby is making a lot of noise for at least 3 consecutive seconds, and the sound of the parent unit is set to silent , the light of the display illuminates.

At the same time the sound alert icon  starts flashing and the parent unit will emit a tone.

15 Menu



### 13 Panel de control

-  Menú / Tecla para Confirmar (véase también 15)
-  Menú hacia arriba / Volumen + (véase también 8)
-  Menú hacia abajo / Volumen - (véase también 8)
-  Volver al paso anterior del menú
-  Encendido/apagado de unidad parental (véase también 4)  
Volver a la pantalla de inicio

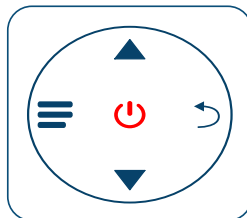



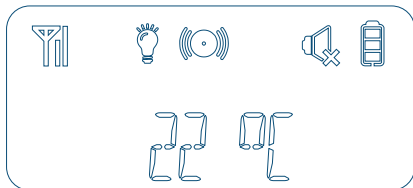





### 14 Pantalla de inicio de unidad principal



TEMP. ALTA = Alerta de temperatura en la unidad del bebé > 30 °C

TEMP. BAJA = Alerta de temperatura en la unidad del bebé < 10 °C

- |   |  |  |
|---|--|--|
|  No hay conexión con la unidad del bebé      |  Alerta de sonido activada                |  Batería en 2/3     |
|  Buena conexión con la unidad del bebé       |  Sonido silenciado en la unidad principal |  Batería en 1/3     |
|  Luz nocturna activada en la unidad del bebé |  Batería totalmente cargada               |  Batería casi vacía |



### Explicación al número 15

#### Sensibilidad

El modo Full Eco se activa cuando el bebé está durmiendo y no produce ningún sonido. La unidad del bebé se pondrá en espera y el transmisor se desactiva para garantizar que no hay más transferencia entre la unidad del bebé y la unidad principal. Cuando el bebé comienza a producir sonidos, el transmisor se activa de nuevo y podrá oír al bebé a través de la unidad principal. La sensibilidad de esta función se puede ajustar en 4 pasos mediante los botones ▲ ▼:

Paso 1 (sensibilidad más inferior) a paso 4 (sensibilidad más alta).  
En el paso 4 el modo Full Eco se desconecta para una conexión continua.



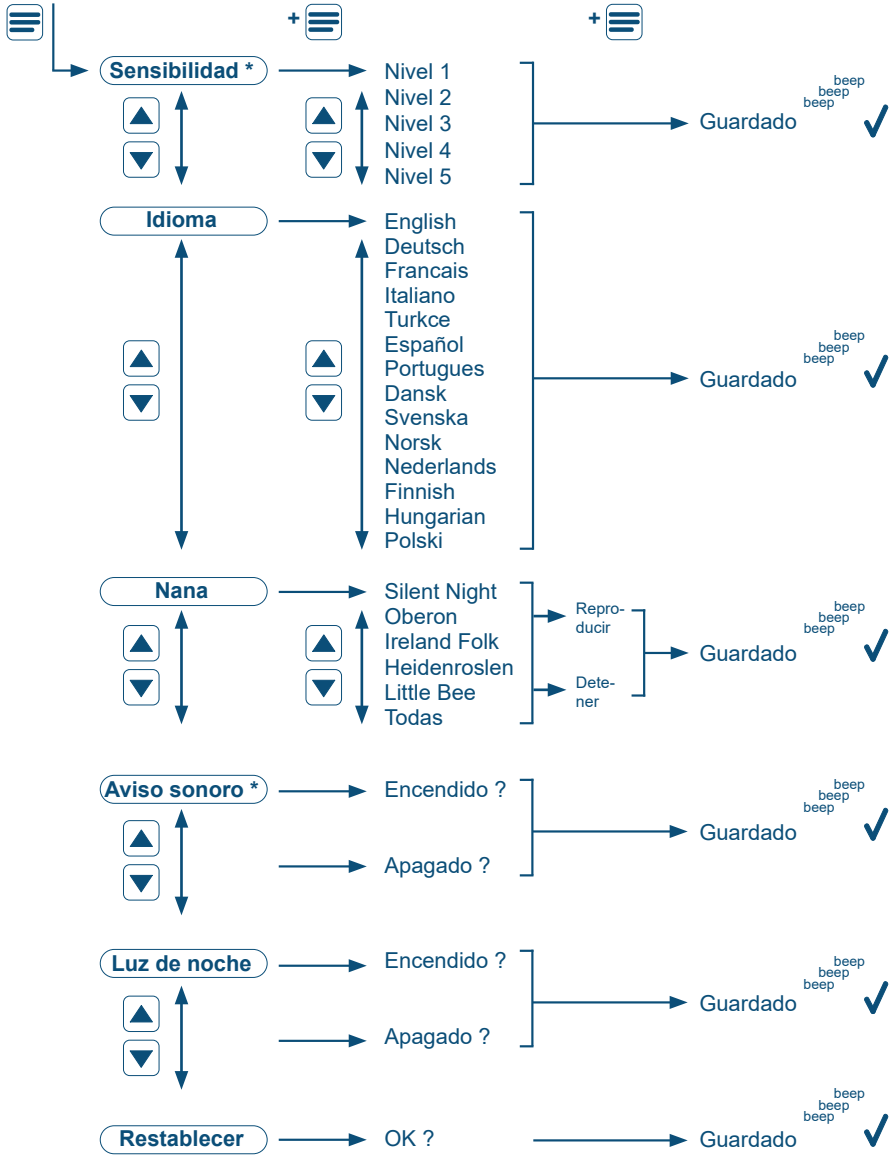

#### Aviso sonoro

Si el bebé produce mucho ruido durante al menos 3 segundos consecutivos, y el sonido de la unidad principal está silenciado , la luz de la pantalla se ilumina. Al mismo tiempo el icono del aviso sonoro  comienza a parpadear y la unidad principal emitirá un sonido.

15 Menú



### 13 Pulsanti Funzione

-  Pulsante Menu button / Pulsante Conferma (vedi anche 15)
-  Su in menu / Volume + (vedi anche 8)
-  Giù in menu / Volume - (vedi anche 8)
-  Torna al passo precedente nel menu
-  Unità genitori Accensione /Spegnimento  
Torna alla schermata di avvio del display (vedi anche 4)

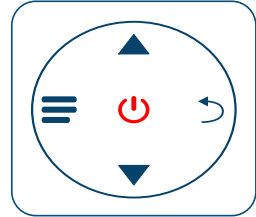



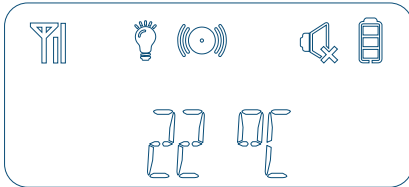





### 14 Schermata di avvio unità genitore



ALTA TEMP. = Temperatura di avviso dell'unità bambino > 30 °C

BASSA TEMP. = Temperatura di avviso dell'unità bambino < 10 °C

- |  |  |   |
|--|--|---|
|  Nessuna connessione con unità bambino        |  Avviso suono                     |  Batteria 2/3 completa     |
|  Buona connessione con unità bambino          |  Audio sull'unità genitore spento |  Batteria complete per 1/3 |
|  Luce notturna è abilitata sull'unità bambino |  Batteria caricata completamente  |  Batteria quasi vuota      |

### Spiegazione su 15

#### Sensibilità

La modalità Eco Completa è attiva quando il bambino sta dormendo e non emette suoni. L'unità bambino passerà poi in standby e la trasmittente è spenta, per assicurare che non ci sia altro traserimento tra l'unità genitori e l'unità bambino.

Quando il bambino inizia ad emettere suoni, la trasmittente p riabilitata e potrai sentire il bambino attraverso l'unità genitore. La sensibilità di questa funzione potrebbe essere impostata 4 passi usando i pulsanti ▲▼:

Da passo 1 (la sensibilità più bassa) a passo 4 (sensibilità più alta).

Al passo 4 la modalità Eco Completa è spenta per consentire una connessione continua.

#### Tono Allarme

Se il bambino fat anti rumori per almeno 3 secondi consecutive e l'audio dell'unità genitore è impostato su silenzioso , la luce del display si illumine.





Allo stesso tempo l'cona di avviso del suono () inizia a lampeggiare e l'unità genitore emetterà un tono.

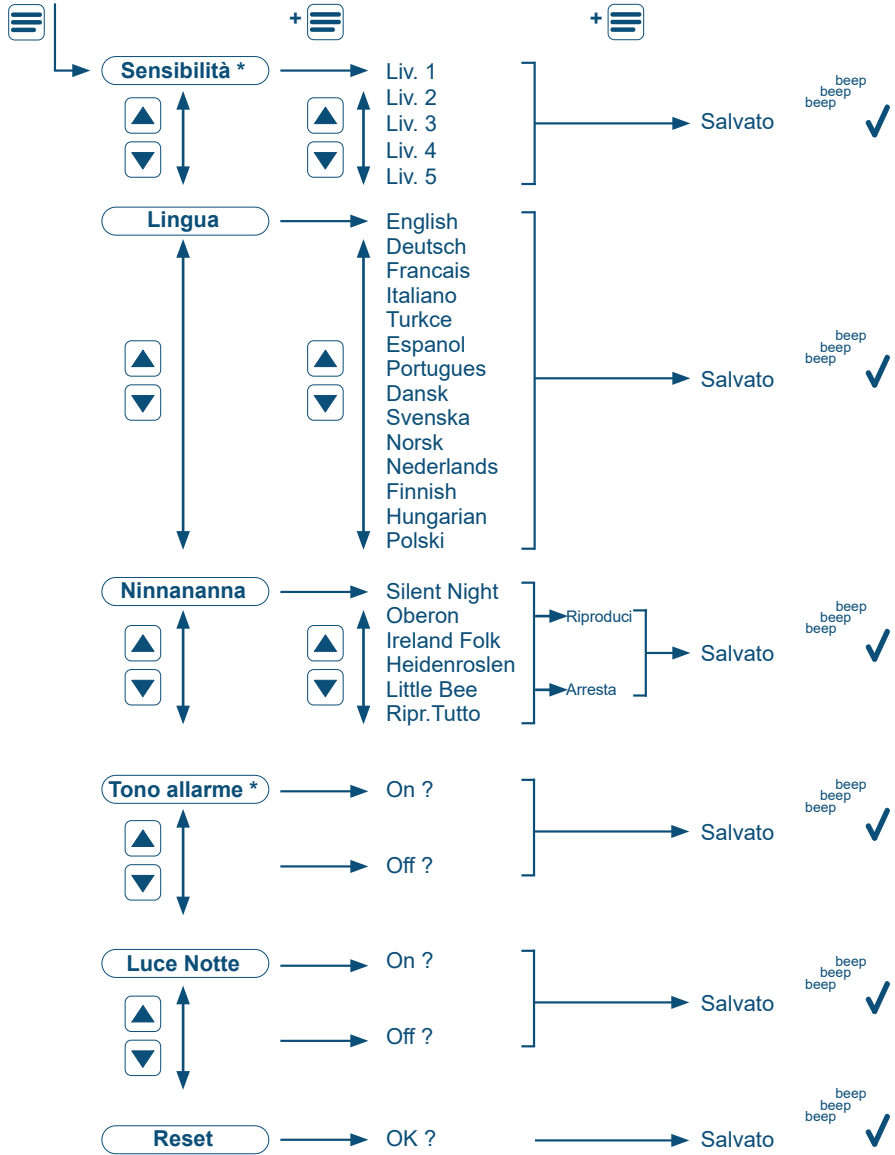

15 Menu



### 13 Funcionamento das teclas

- |   |                                 |                 |
|---|---------------------------------|-----------------|
|  | Tecla Menu /Tecla Confirmar     | (ver também 15) |
|  | Subir no menu / Volume +        | (ver também 8)  |
|  | Descer no menu / Volume -       | (ver também 8)  |
|  | Voltar à etapa anterior no menu |                 |
|  | Ligar e desligar unidade pai    | (ver também 4)  |
- Parte posterior do ecrã de início do visor

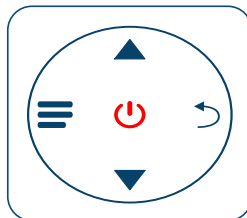



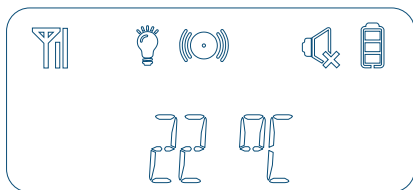





### 14 Ecrã de início da unidade pai



TEMP. ALTA = Alerta de temperatura da unidade criança > 30 °C

TEMP. BAIXA = Alerta de temperatura da unidade criança < 10 °C

- |   |                                      |   |                              |   |                     |
|---|--------------------------------------|---|------------------------------|---|---------------------|
|  | Sem ligação com unidade criança      |  | Alerta de som ativo          |  | Bateria 2/3 cheia   |
|  | Boa ligação com unidade criança      |  | Som na unidade pai desligado |  | Bateria 1/3 cheia   |
|  | Luz noturna ativa na unidade criança |  | Bateria totalmente carregada |  | Bateria quase vazia |

### Explicação em 15

#### Sensibilidad.

O modo Full Eco está ativo quando a criança está a dormir e não faz quaisquer sons.

A unidade criança passa para standby e o transmissor desliga-se para garantir que não existe mais transferências entre a unidade criança e a unidade pai.

Quando a criança começa a fazer sons, o transmissor volta a ligar-se e pode ouvir a criança através da unidade pai. A sensibilidade desta função pode ser definida em 4 etapas, com as teclas ▲▼:

Etapa 1 (sensibilidade mínima) até etapa 4 (sensibilidade máxima).

Na etapa 4 o modo Full Eco é desligado para permitir uma ligação contínua.

#### Aviso sonoro



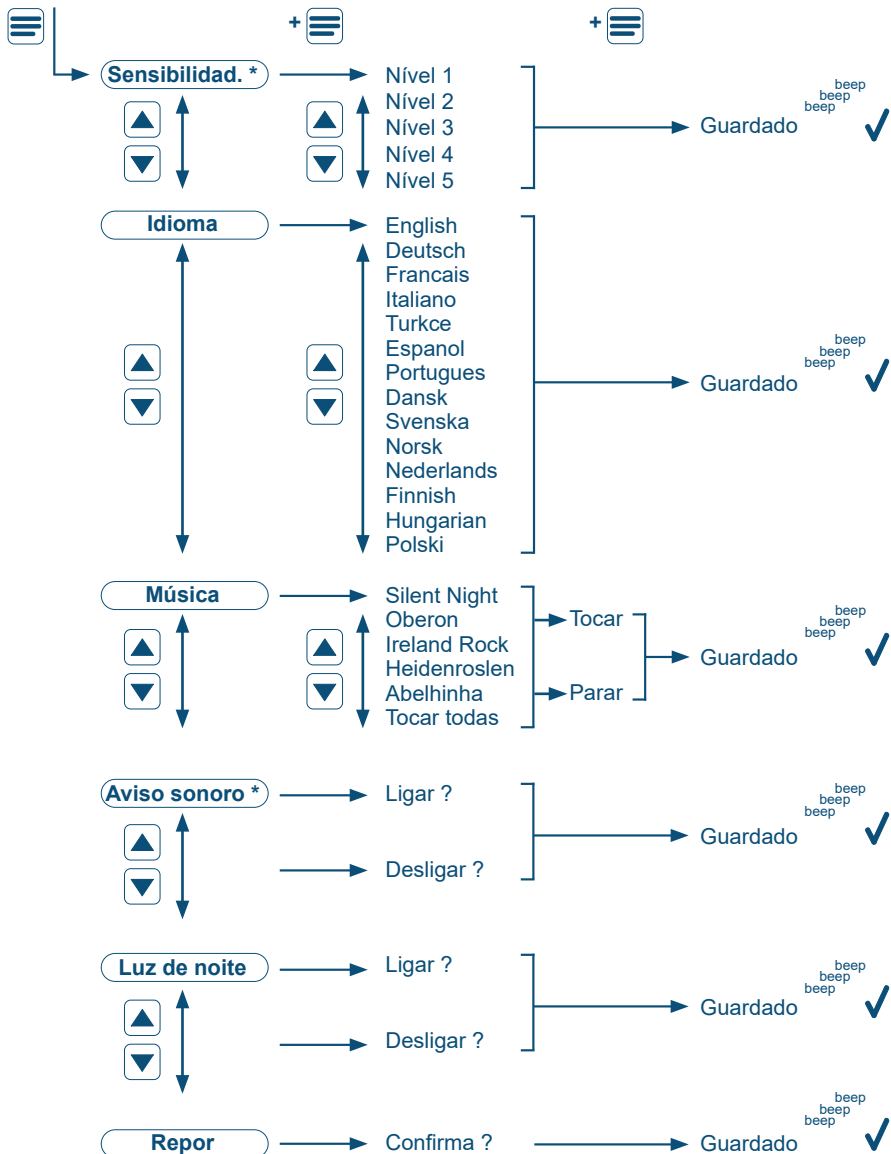

Se a criança estiver a fazer muito barulho durante pelo menos 3 segundos seguidos, e o som da unidade pai estiver no silêncio , a luz do visor acende-se.

Ao mesmo tempo, o ícone de alerta de som  começa a piscar e a unidade pai irá emitir um som.

15 Menu



### 13 Przyciski obsługi

-  Przycisk menu / Przycisk potwierdzenia (zobacz także 15)
-  Menu w górę / Głośność + (zobacz także 8)
-  Menu w dół / Głośność - (zobacz także 8)
-  Powrócić do poprzedniego kroku w menu
-  Urządzenie macierzyste włączanie i wyłączanie (zobacz także 4)  
Powrót do ekranu uruchamiania

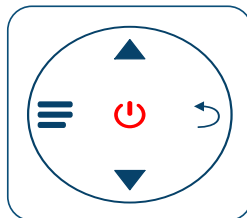



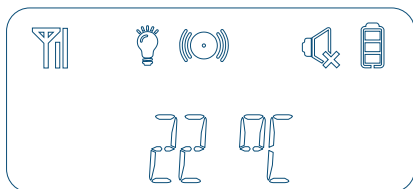





### 14 Ekran uruchamiania modułu rodzica



WYS TEMP = Alert temperatury modułu dziecka > 30 °C

NISKA TEMP = Alert temperatury modułu dziecka < 10 °C

- |   |  |  |
|---|--|--|
|  Brak połączenia z modułem dziecka         |  Aktywny jest sygnał ostrzegawczy       |  Bateria jest naładowana w 2/3              |
|  Dobre połączenie z modułem dziecka        |  Dźwięk w module rodzica jest wyłączony |  Bateria jest naładowana w 1/3              |
|  Czynna jest nocna lampka w module dziecka |  Bateria jest w pełni naładowana        |  Bateria jest niemal całkowicie rozładowana |

### Objaśnienie na 15

#### Czułość

Tryb Full Eco (Rozsz. Eko) jest aktywny, gdy dziecko śpi i nie wydaje żadnych odgłosów.

Wtedy moduł dziecięcy przechodzi do trybu czuwania, a nadajnik wyłącza się tak, aby zapewnić brak przesyłu danych pomiędzy modułem dziecka a modułem rodzica.

Gdy dziecko zaczyna wydawać dźwięki, ponownie uruchamia się nadajnik; z modułu rodzica można słyszeć aktywność dziecka. Czułość tej funkcji można ustawiać w 4 krokach przy pomocy przycisków ▲▼ : Krok 1 (czułość najniższa) do kroku 4 (czułość najwyższa).

W kroku 4 tryb Full Eco (Rozsz. Eko) zostanie wyłączony w celu umożliwienia stałego połączenia.

#### Sygn. ostrz



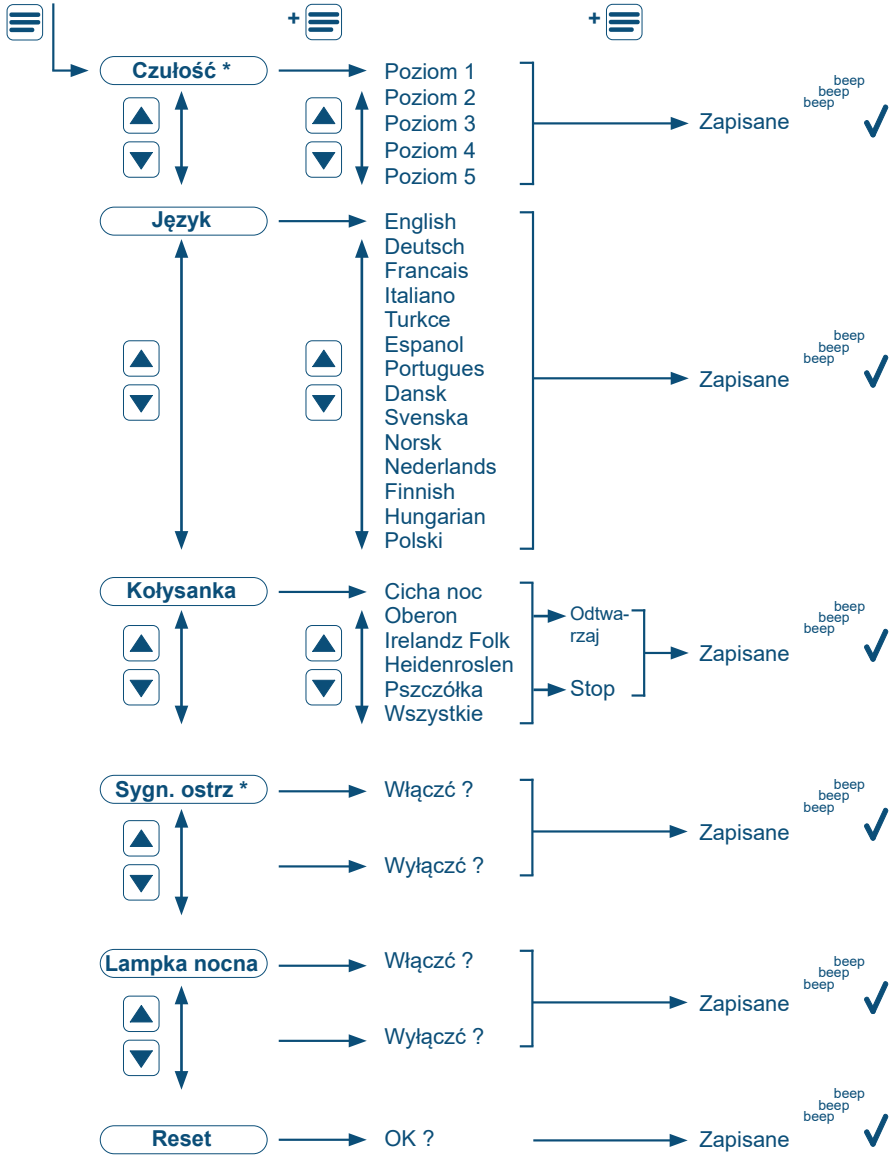

Jeśli dziecko robi dużo hałasu, przez co najmniej 3 kolejne sekundy, a dźwięk w module rodzica jest wyciszony , na wyświetlaczu zapala się lampka.

Jednocześnie zaczną migać ikonka sygnału dźwiękowego () i moduł rodzica emituje sygnał dźwiękowy.

15 Menu



### 13 Funcționarea butoanelor

-  Buton Meniu / Buton Confirmare (vezi și 15)
-  Sus în meniu / Volum + (vezi și 8)
-  Jos în meniu / Volum - (vezi și 8)
-  Reveniți la pasul anterior din meniu
-  Unitatea parentală activată și dezactivată (vezi și 4)  
Înapoi la ecranul de pornire al afișajului

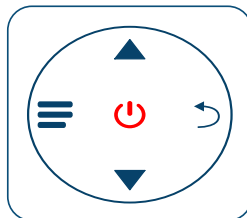



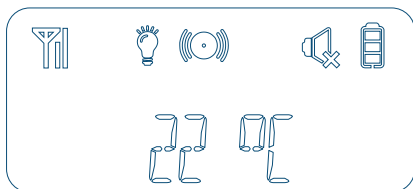





### 14 Ecranul de pornire a unității parentale



HI TEMP = Alertă temperatură unitate copil > 30 °C

LO TEMP = Alertă temperatură unitate copil < 10 °C

- |   |   |   |  |   |                       |
|---|---|---|--|---|-----------------------|
|  | Nici o legătură cu unitatea pentru copii                |  | Alerta de sunet este activată            |  | Baterie plină 2/3     |
|  | Conexiune bună cu unitatea pentru copii                 |  | Sunetul pe unitatea parentală este oprit |  | Baterie plină 1/3     |
|  | Lumina de noapte este activată pe unitatea pentru copii |  | Baterie încărcată complet                |  | Baterie aproape goală |

### Explicație la 15

#### Sensitivity

Modul Eco complet este activ când bebelușul doarme și nu produce sunete.

Unitatea pentru copii va trece apoi în modul standby și transmițătorul va fi oprit, pentru a vă asigura că nu mai există transfer între unitatea pentru copii și unitatea parentală.

Când bebelușul începe să producă sunete, emițătorul este activat din nou și veți putea auzi copilul prin unitatea parentală. Sensibilitatea acestei funcții poate fi stabilită în 4 pași utilizând butoanele ▲ ▼:

Pasul 1 (cea mai mică sensibilitate) până la pasul 4 (cea mai mare sensibilitate).

La pasul 4, modul Eco complet este oprit pentru a permite o conexiune continuă.

#### Sound alert



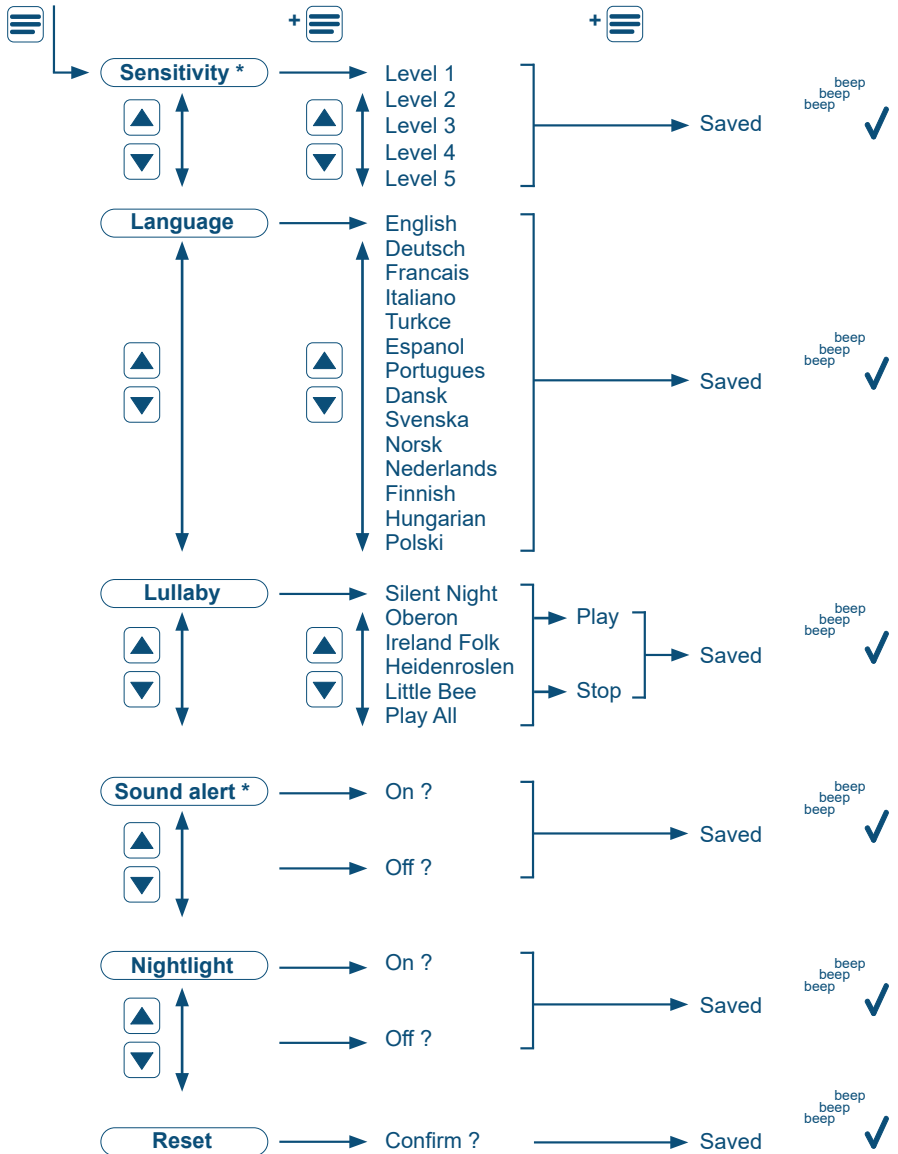

Dacă bebelușul produce mult zgomot timp de cel puțin 3 secunde consecutive, iar sunetul unității parentale este setat la tăcere , lumina afișajului se aprinde.

În același timp, pictograma de avertizare sonoră  începe să clipească și unitatea parentală va emite un sunet.

15 Meniu



### 13 Λειτουργία κουμπιών

-  Κουμπί μενού / Επιβεβαιώστε κουμπί (βλέπε επίσης το 15)
-  Πάνω στο μενού / Ένταση ήχου + (βλέπε επίσης το 8)
-  Κάτω στο μενού / Ένταση ήχου - (βλέπε επίσης το 8)
-  Επιστροφή στο προηγούμενο βήμα στο μενού
-  Μονάδα γονέα ενεργοποιημένη και απενεργοποιημένη Πίσω στην απεικόνιση της οθόνης έναρξης (βλέπε επίσης το 4)

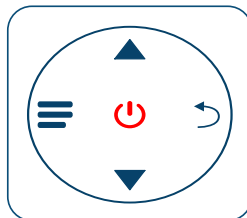

### 14 Οθόνη έναρξης μονάδα γονέα

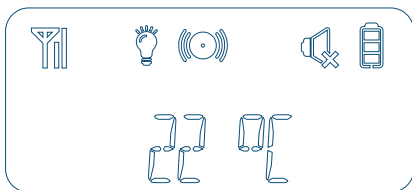

HI TEMP = Συναγερμός θερμοκρασίας της μονάδας βρέφους > 30 °C

LO TEMP = Συναγερμός θερμοκρασίας της μονάδας βρέφους < 10 °C

- |  |   |   |
|--|---|---|
|  Μη σύνδεση με τη μονάδα βρέφους                          |  Ο συναγερμός ήχου είναι ενεργοποιημένος         |  Μπαταρία πλήρης κατά τα 2/3 |
|  Καλή σύνδεση με τη μονάδα βρέφους                        |  Ο ήχος στη μονάδα γονέα είναι απενεργοποιημένος |  Μπαταρία πλήρης κατά το 1/3 |
|  Το φωτάκι νυκτός είναι ενεργοποιημένο στη μονάδα βρέφους |  Μπαταρία πλήρως φορτισμένη                      |  Μπαταρία σχεδόν άδεια       |

### Επεξήγηση στο 15

#### Sensitivity

Ο Πλήρης Οικονομικός τρόπος λειτουργίας είναι ενεργός όταν το βρέφος κοιμάται και δεν κάνει ήχους. Η μονάδα βρέφους θα μεταβεί τότε σε κατάσταση αναμονής και ο μεταδότης απενεργοποιείται, για να εξασφαλιστεί ότι δεν υπάρχει πλέον μεταφορά ανάμεσα στη μονάδα βρέφους και τη μονάδα γονέα. Όταν το βρέφος ξεκινήσει να κάνει ήχους, ο μεταδότης τίθεται ξανά σε λειτουργία και θα μπορείτε να ακούτε το βρέφος μέσω της μονάδας γονέα. Η ευαισθησία αυτής της λειτουργίας μπορεί να ρυθμιστεί σε 4 βήματα χρησιμοποιώντας τα ▲ ▼ κουμπιά:

Βήμα 1 (κατώτατη ευαισθησία) έως βήμα 4 (ύψιστη ευαισθησία).

Στο βήμα 4 ο Πλήρης Οικονομικός τρόπος λειτουργίας απενεργοποιείται για να επιτρέψει μια συνεχή σύνδεση.

#### Sound alert

Εάν το βρέφος κάνει πολύ θόρυβο για τουλάχιστον 3 διαδοχικά δευτερόλεπτα, και ο ήχος της γονικής μονάδας έχει ρυθμιστεί σε σιωπηλό τρόπο λειτουργίας , η οθόνη φωτίζεται.





Ταυτόχρονα, το εικονίδιο του ηχητικού συναγερμού  ξεκινάει να αναβοσβήνει και η μονάδα γονέα θα εκπέμψει έναν ηχητικό τόνο.

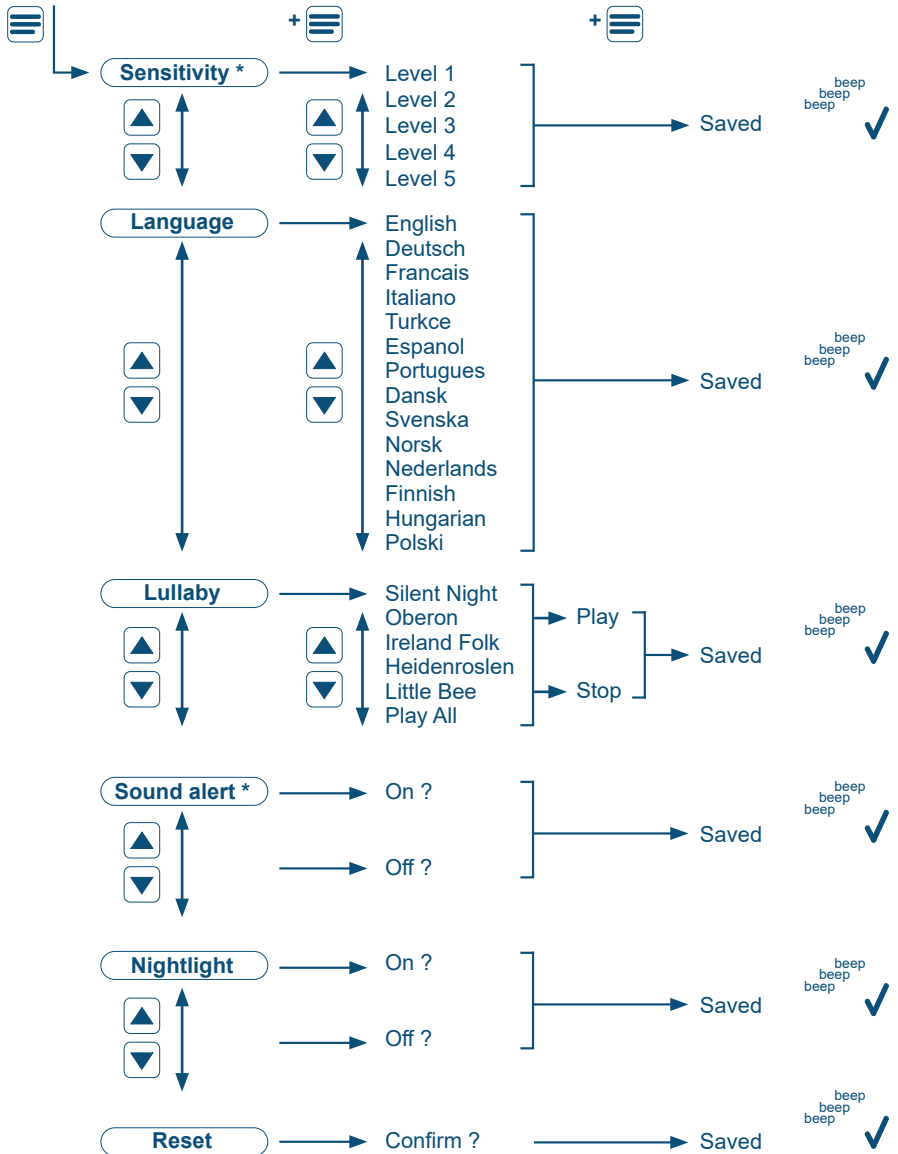

15 Μενού



### 13 Funkce tlačítek

-  Tlačítko nabídky / Potvrzovací tlačítko (viz také 15)
-  Nahoru v nabídce / Zvýšení hlasitosti (viz také 8)
-  Dolů v nabídce / Snížení hlasitosti (viz také 8)
-  Návrat na předchozí krok v nabídce
-  Vypnutí/zapnutí rodičovské jednotky (viz také 4)  
Zpět na úvodní obrazovku

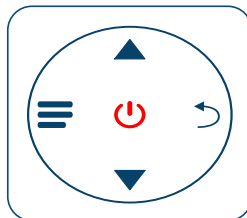



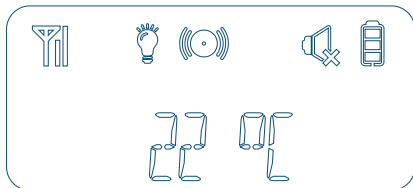





### 14 Úvodní obrazovka rodičovské jednotky



HI TEMP = Upozornění na teplotu dětské jednotky nad 30 °C

LO TEMP = Upozornění na teplotu dětské jednotky pod 10 °C

- |   |   |  |
|---|---|--|
|  Dětská jednotka není připojena              |  Zvukové upozornění je povoleno        |  Baterie nabita ze dvou třetin  |
|  Kvalitní spojení s dětskou jednotkou        |  Zvuk na rodičovské jednotce je vypnut |  Baterie nabita z jedné třetiny |
|  Noční světlo na dětské jednotce je povoleno |  Baterie plně nabita                   |  Baterie téměř vybita           |

## Vysvětlení na 15

### Sensitivity

Když dítě spí a nevydává zvuky, je zapnut úplný ekologický režim (Full Eco).

Dětská jednotka se přepne do pohotovostního stavu a vypne se její vysílač, takže nedochází k přenosu mezi dětskou jednotkou a rodičovskou jednotkou.

Jakmile začne dítě vydávat zvuky, vysílač v dětské jednotce se znovu zapne a přes rodičovskou jednotku je slyšet. Citlivost (Sensitivity) této funkce lze nastavit ve čtyřech úrovních pomocí tlačítek ▲▼: stupeň 1 (nejnižší citlivost) až stupeň 4 (nejvyšší citlivost).

Na stupni 4 se vypne režim Full Eco a spojení mezi jednotkami je trvalé.

### Sound alert



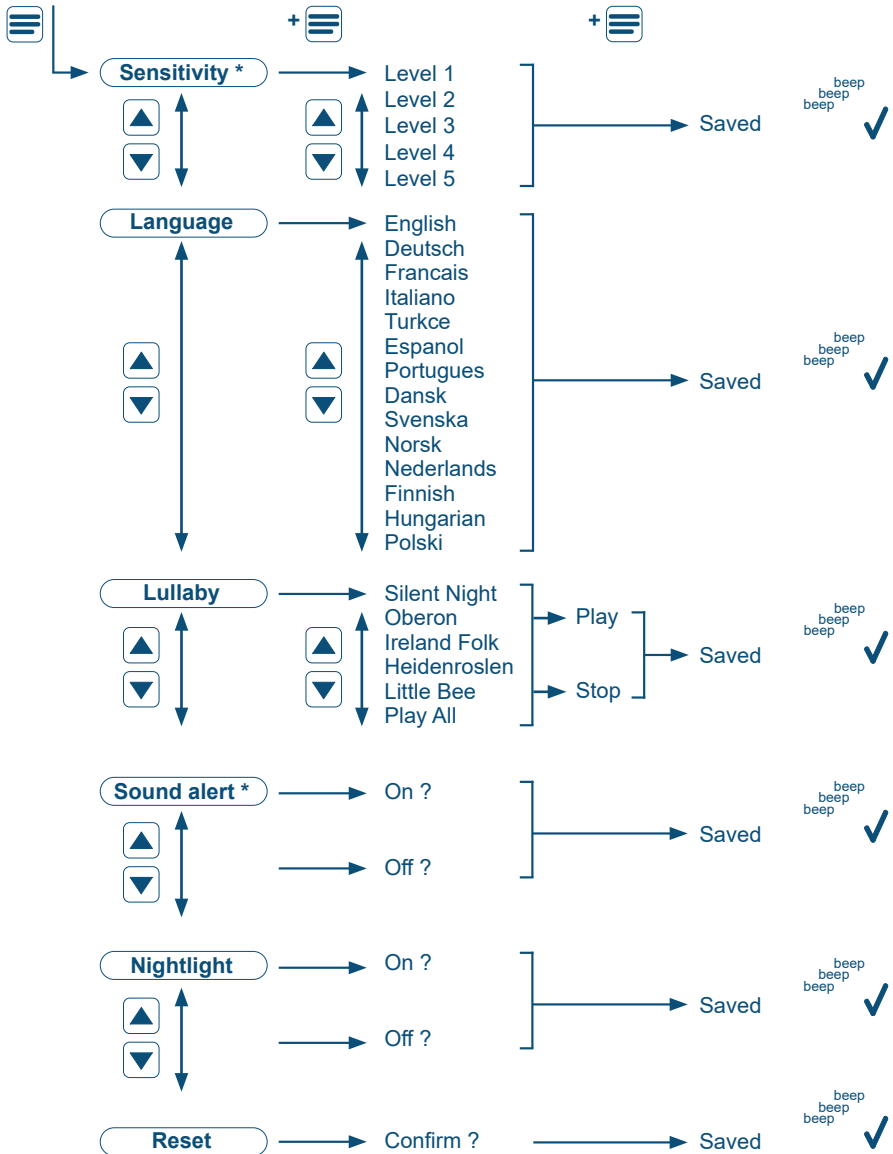

Pokud dítě vytváří značný hluk alespoň po 3 sekundách a zvuk je na rodičovské jednotce nastaven na ticho (🔇), zapne se osvětlení displeje.

Současně začne blikat ikona upozornění (🔊) a rodičovská jednotka vydá zvukové upozornění.

15 Nabídka



## 13 Knappar

-  Menyknapp / Bekräftaknapp (se även 15)
-  Uppåt i menyn / Volym + (se även 8)
-  Nedåt i menyn / Volym - (se även 8)
-  Åter till föregående steg i menyn
-  Av och på för föräldraenhet (se även 4)  
Åter till displayens startbild

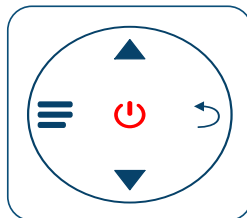



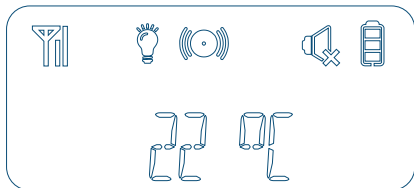





## 14 Startbild för föräldraenhet



HÖG TEMP = Tempvarning för babyenhet &gt; 30 °C

LÅG TEMP = Tempvarning för babyenhet &lt; 10 °C

- |  |  |   |
|--|--|---|
|  Ingen kontakt med baby enhet       |  Ljudvarning aktiverad    |  Batteri 2/3 fullt   |
|  God kontakt med babyenhet          |  Ljud av på föräldraenhet |  Batteri 1/3 fullt   |
|  Nattpampa aktiverad på babyenheten |  Batteri fulladdat        |  Batteri nästan tomt |

## Förklaring till 15

## Känslighet

Fullt ekoläge är aktivt när babyn sover och inte ger några ljud ifrån sig.



Babyenheten får då över till standby-läge och kommunikationen mellan babyenhet och föräldraenhet stängs av.

När babyn ger ljud ifrån sig aktiveras sändaren igen och barnet kan då höras i föräldraenheten. Den här funktionen har 4 känslighetssteg som ställs in med ▲▼-knapparna:

Från steg 1 (lägst känslighet) till steg 4 (högst känslighet).

I steg 4 slås fullt ekoläge av och ersätts av kontinuerlig kommunikation.

## Varningsljud

Om babyn ger mycket ljud ifrån sig i minst 3 sekunder och föräldraenheten står på tyst , tänds displayen. Samtidigt blinkar ljudlarmikonen  och en ton avges från föräldraenheten.

## 15 Meny

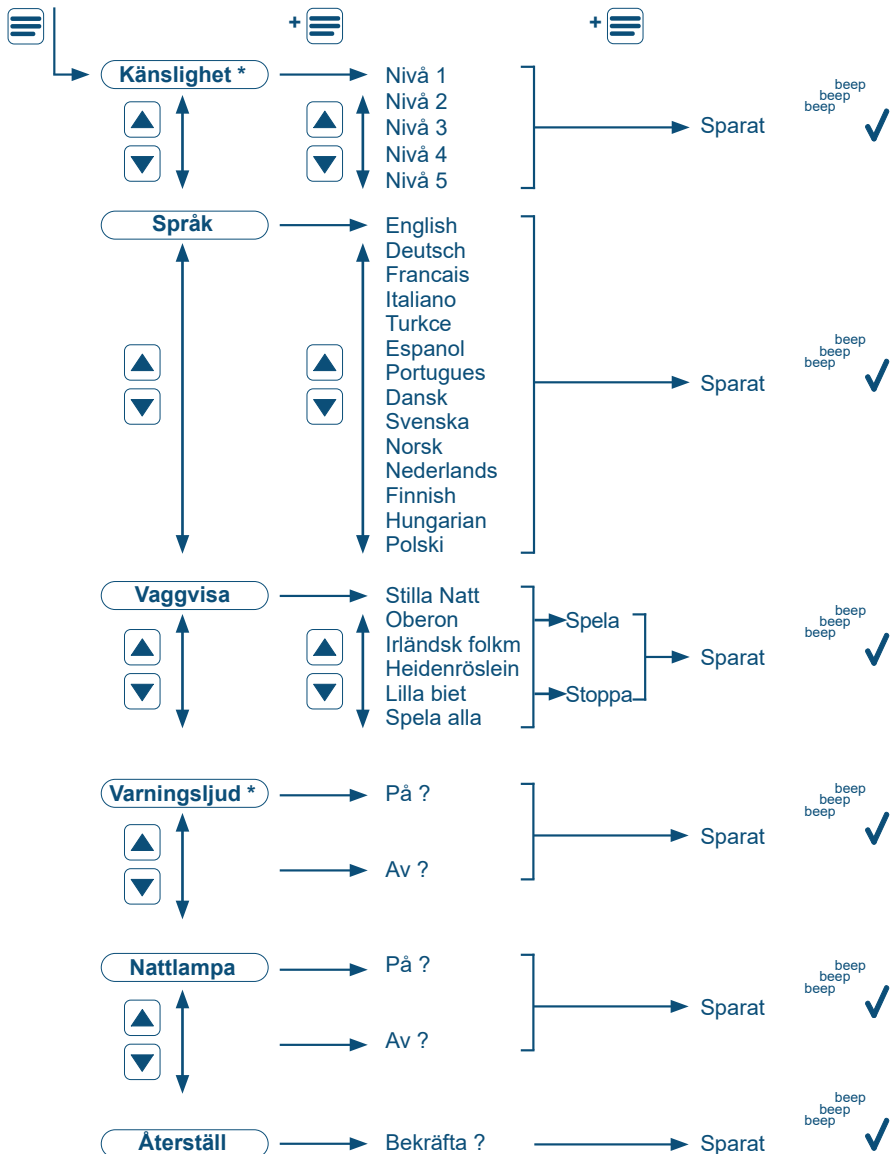

### 13 Knapbetjening

-  Menu-knap / Bekræft-knap (se også 15)
-  Op i menu / lydstyrke + (se også 8)
-  Ned i menu / lydstyrke - (se også 8)
-  Tilbage til foregående niveau i menuen
-  Styreenhed Til og Fra (se også 4)  
Tilbage til displayets startskærm

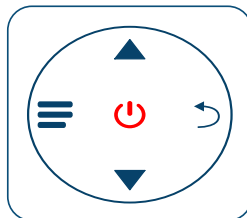

### 14 Styreenhed startskærm

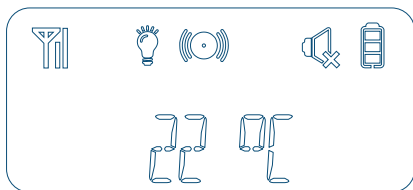

HØJ TEMP = Underenhed temperaturadvarsel  
> 30°C

LAV TEMP = Underenhed temperaturadvarsel  
< 10°C



- |   |   |  |
|---|---|--|
|  Ikke forbindelse til underenhed   |  Lydalarm er aktiveret       |  Batteri 2/3 opladet    |
|  God forbindelse til underenhed    |  Lyd på styreenhed slået fra |  Batteri 1/3 opladet    |
|  Natlys er aktiveret på underenhed |  Batteri helt opladet        |  Batteri næsten afladet |

### Forklaring til 15

#### Følsomhed

Udvidet Eco-tilstand er aktiv, når barnet sover og ikke laver lyde. Underenheden skifter da til standby, og senderen slukkes for at sikre, at der ikke længere sker transmission mellem under- og styreenhed. Når barnet begynder at lave lyde, aktiveres senderen igen, og man vil kunne høre barnet gennem styreenheden. Følsomheden af denne funktion kan indstilles i 4 niveauer med ▲ ▼ knapperne: Niveau 1 (laveste følsomhed) til niveau 4 (højeste følsomhed). I niveau 4 slås Udvidet Eco-tilstand fra for at muliggøre konstant forbindelse.



#### Lydalarm

Hvis barnet laver megen støj i mindst 3 sekunder i træk, og lyden på styreenheden er sat til lydløs , lyser displayet. Samtidigt begynder lydalarm-ikonet () at blinke, og styreenheden udsender en tone.

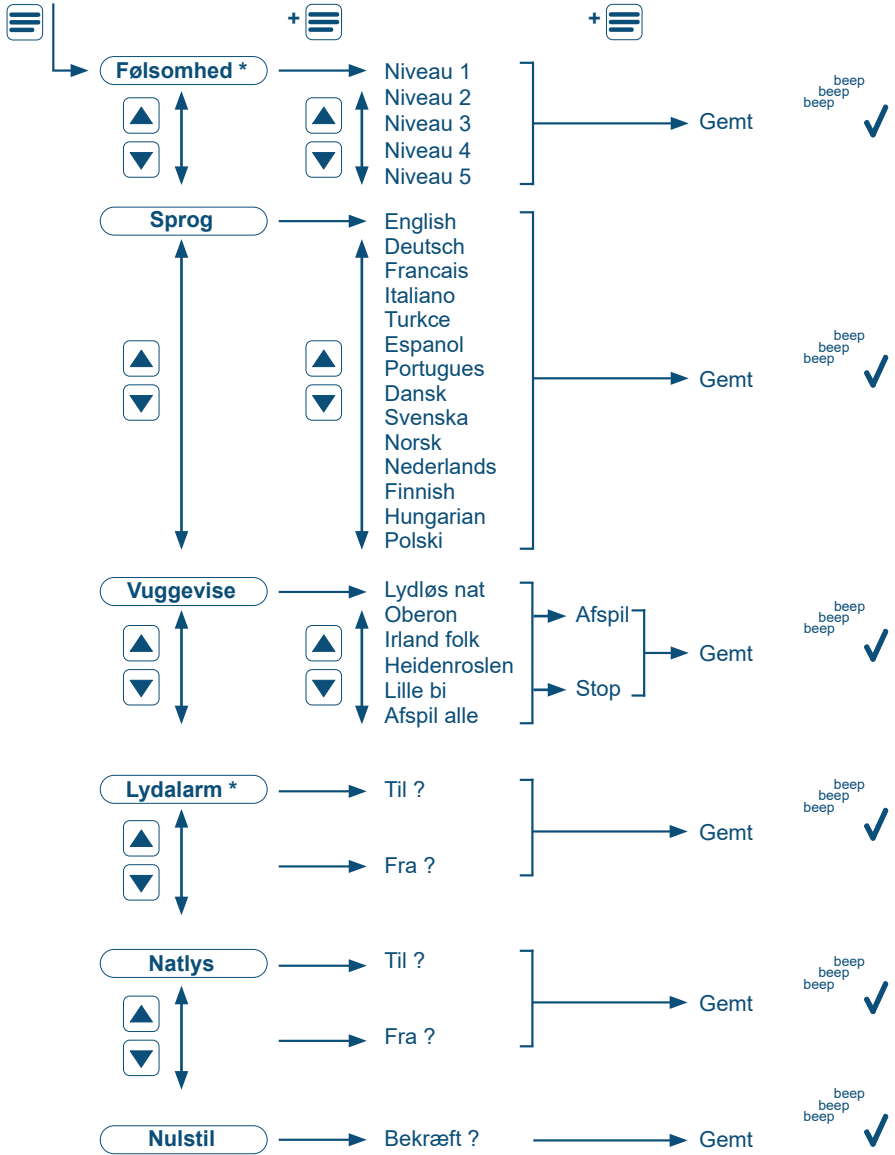
15 Menu



### 13 Knapper for betjening

-  Menyknapp / bekreftknapp (se også 15)
-  Opp i meny / volum + (se også 8)
-  Ned i meny / volum - (se også 8)
-  Tilbake til forrige steg i menyen
-  Foreldreheten på og av (se også 4)  
Tilbake til skjermens oppstarts-skjerm bilde

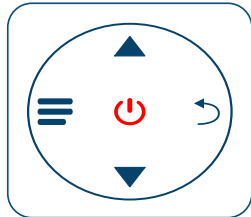

### 14 Foreldreheten oppstarts-skjerm bilde

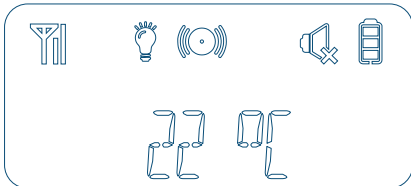

Høy temp = Babyenhet temperaturvarsling > 30 °C

Lav temp = Babyenhet temperaturvarsling < 10 °C

- |   |  |   |
|---|--|---|
|  Ingen forbindelse med babyenhet |  Lydvarsling er aktivert    |  Batteri 2/3 fullt   |
|  God forbindelse med babyenhet   |  Lyd på foreldreheten er av |  Batteri 1/3 fullt   |
|  Nattlys på babyenheten er på    |  Batteriet er fulladet      |  Batteri nesten tomt |

### Forklaring på 15

#### Følsomhet

Full strømsparingsmodus er aktivert når babyen sover og ikke lager lyd.

Babyenheten vil da gå i sovemodus, og senderen slås av for å sikre at det ikke er mer signaler som sendes mellom babyenheten og foreldreneheter.

Når babyen igjen lager lyder, vil senderen aktiveres igjen, og du vil være i stand til å høre babyen via foreldreheten. Sensitiviteten i denne funksjonen kan stilles inn i fire steg ved å bruke ▲ ▼ tastene: Nivå 1 (lavest sensitivitet) til nivå 4 (høyest sensitivitet).

På nivå 4 er full strømsparingsmodus slått av slik at det er kontinuerlig forbindelse.

#### Lydvarsel

Dersom babyen lager mye lyd i minst tre sekunder på rad, og lyden på foreldreheten er deaktivert , vil bakgrunnslys på skjermen lyse.





Samme tid vil lydvarsel-ikonet  starte å blinke, og foreldreheten vil sende ut en tone.

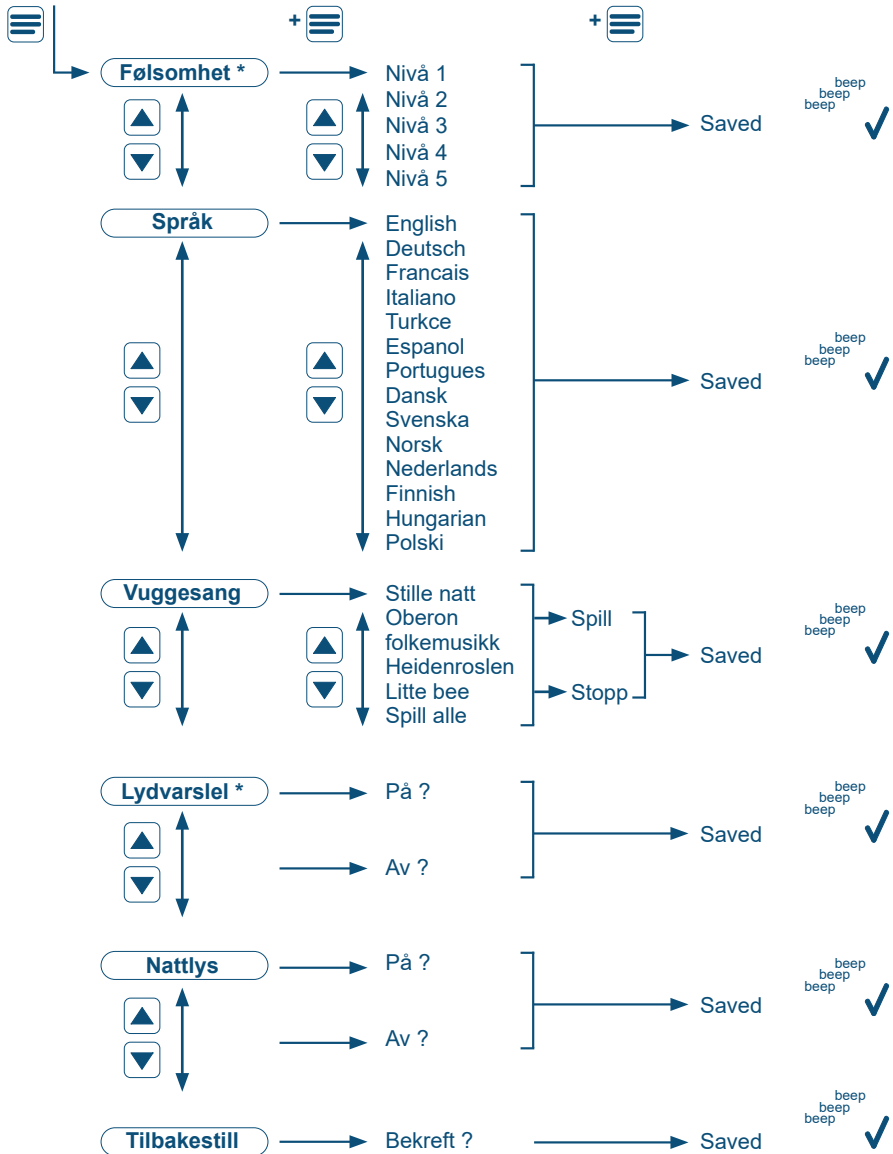

15 Menu



### 13 Painikkeiden toiminto

-  Valikkopainike / Vahvistuspainike1 (katso myös 15)
-  Ylös valikossa / Äänentaso + (katso myös 8)
-  Alas valikossa / Äänentaso - (katso myös 8)
-  Palaa edelliseen vaiheeseen valikossa
-  Emoyksikkö päälle ja pois (katso myös 4)  
Takaisin näytön aloitusnäyttöön

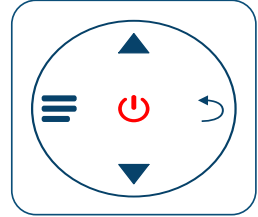



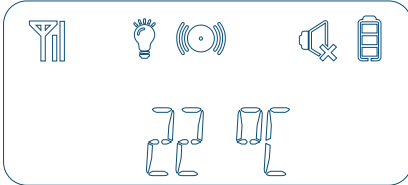





### 14 Emoyksikön aloitusnäyttö



KORKEA LÄMPÖ = Lapsiyksikön lämpötilahälytys > 30 °C

ALH. LÄMPÖ = Lapsiyksikön lämpötilahälytys < 10 °C

- |  |   |  |
|--|---|--|
|  Ei yhteyttä lapsiyksikköön   |  Äänihälytys päällä                  |  Akku 2/3 täynnä  |
|  Hyvä yhteys lapsiyksikköön   |  Vanhempien yksikön ääni pois päältä |  Akku 1/3 täynnä  |
|  Yövalo päällä lapsiyksikössä |  Akku täyteen ladattu                |  Akku lähes tyhjä |

### Kuvaus kohdassa 15

#### Herkkyys

Täysi Eco-tila on käytössä, kun lapsi nukkuu eikä ääntele.

Lapsen yksikkö vaihtuu valmiustilaan ja lähetin sammutetaan varmistamaan, ettei lapsen ja vanhempien yksikön välillä ole tiedonsiirtoa.

Kun lapsi alkaa äänтелеään, lähetin kytkeytyy päälle ja kuulet lapsen vanhempien yksiköstä. Tämän toiminnon herkkyys voidaan asettaa 4 vaiheessa ▲ ▼ painikkeilla:

Vaiheesta 1 (alin herkkyys) vaiheeseen 4 (korkein herkkyys).

Vaiheessa 4, Täysi Eco-tila on kytketty pois päältä, jatkuvan yhteyden säilyttämiseksi.

#### Äänihälytys



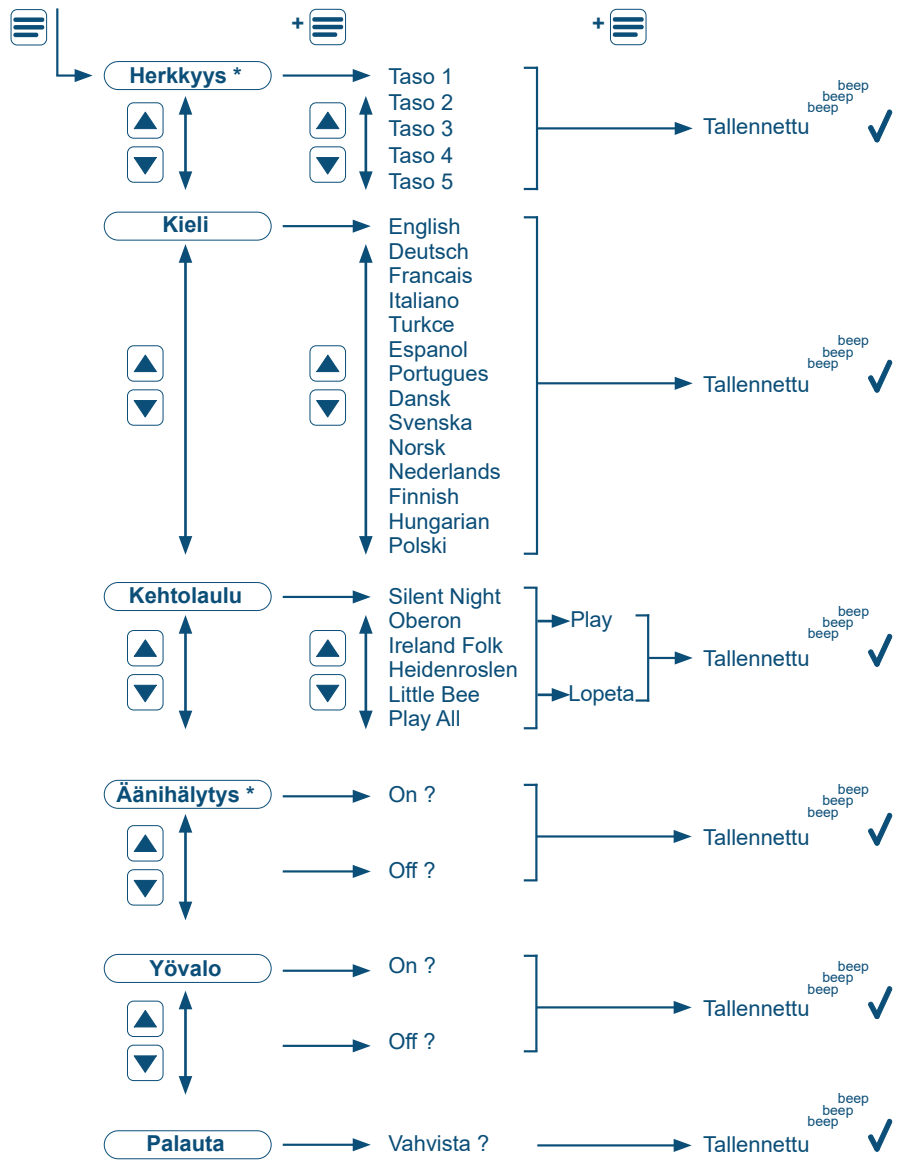

Jos lapsi äänтелеe paljon vähintään 3 sekunnin ajan, ja vanhempien yksikön ääni on asetettu hiljaiselle , valo näytöllä syttyy.

Samalla äänihälytyksen kuvake  alkaa vilkkumaan ja vanhempien yksiköstä kuuluu merkkiäänä.

15 Valikko



### 13 Кнопки управления

-  Кнопка меню / Кнопка подтверждения (также см. п. 15)
-  “Вверх” в меню / Громкость + (также см. п. 8)
-  “Вниз” в меню / Громкость - (также см. п. 8)
-  Возврат к предыдущему шагу в меню
-  Вкл. и выкл. родительской части (также см. п. 4)  
Возврат к начальному экрану

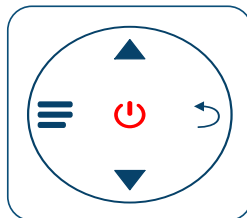



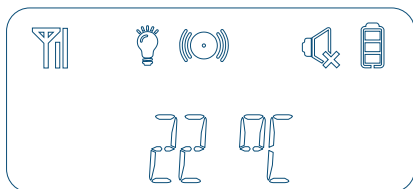





### 14 Начальный экран родительской части



HI TEMP = Сигнал, что температура детской части > 30 °C

LO TEMP = Сигнал, что температура детской части < 10 °C

- |   |  |  |
|---|--|--|
|  Нет соединения с детской частью     |  Звуковой сигнал включен            |  Аккумулятор заряжен на 2/3 |
|  Хорошее соединение с детской частью |  Звук в родительской части выключен |  Аккумулятор заряжен на 1/3 |
|  Ночник в детской части включен      |  Аккумулятор полностью заряжен      |  Аккумулятор почти разряжен |

### Объяснение п. 15

#### Sensitivity

Режим “Full Eco” активируется, когда ребенок спит, и не издает никаких звуков. В этом случае, детская часть переключается в дежурный режим и передатчик выключается, чтобы между родительской и детской частями не передавалось никаких сигналов.

Когда ребенок начинает издавать звуки, передатчик активируется снова, и вы сможете услышать ребенка с помощью родительской части. Чувствительность этой функции можно регулировать с помощью 4 шагов, используя кнопки ▲▼:

Шаг 1 (самая низкая чувствительность), и до шага 4 (самая высокая чувствительность). На шаге 4, режим “Full Eco” выключается, чтобы установилось постоянное соединение.

#### Sound alert



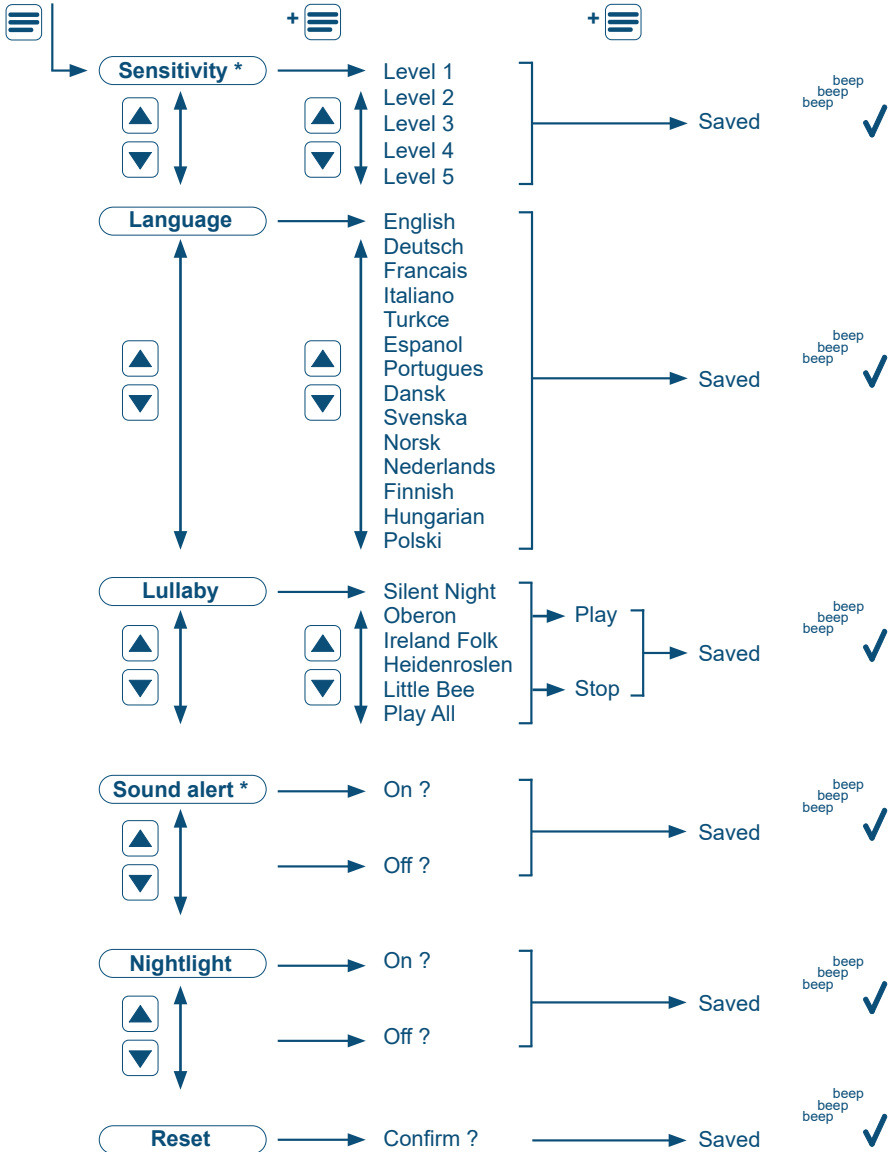

Если ребенок шумит в течение, по крайней мере, 3 секунд подряд, а звук в родительской части выключен (значок ) , экран начинает светиться.

Одновременно с этим, значок звукового сигнала () начинает мигать, и родительская часть издает звуковой сигнал.

15 Меню



### 13 Operacija taster

-  Taster za meni / potvrđivanje (vidi i 15)
-  Gore u meniju / Jačina + (vidi i 8)
-  Dole u meniju / Jačina - (vidi i 8)
-  Povratak na prethodni korak u meniju
-  Roditeljska jedinica uključeno / isključeno (vidi i 4)  
Povratak na osnovni ekran

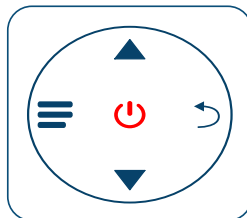



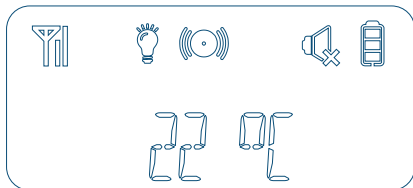





### 14 Početni ekran roditeljske jedinice



HI TEMP = Upozorenje sa bebi-jedinice  
temperatura > 30 °C

LO TEMP = Upozorenje sa bebi-jedinice  
temperatura < 10 °C

- |   |   |   |
|---|---|---|
|  Nema veze sa bebi-jedinicom             |  Alarm uključen                          |  Baterija 2/3 puna         |
|  Dobra veza sa bebi-jedinicom            |  Isključen zvuk na roditeljskoj jedinici |  Baterija 1/3 puna         |
|  Noćno svetlo uključeno na bebi-jedinici |  Baterija napunjena                      |  Baterija je gotovo prazna |

### Objašnjenje za 15

#### Sensitivity

Puni Eko režim je aktivan kada beba spava i ne pravi nikakve zvukove. Tada se uređaj samostalno prebacuje na režim mirovanja i predajnik se isključuje da više ne bi bilo prenosa između bebi-jedinice i roditeljske jedinice. Kada beba počne da pravi zvukove, predajnik se ponovo uključuje i vi ćete moći da čujete bebu preko roditeljske jedinice. Osetljivost ove funkcije može se podesiti na četiri nivoa pomoću tastera: ▲ ▼ od Nivoa 1 (najniža osetljivost) do Nivoa 4 (najveća osetljivost). Na nivou 4, Eko režim se gasi i omogućava neprekidnu vezu.



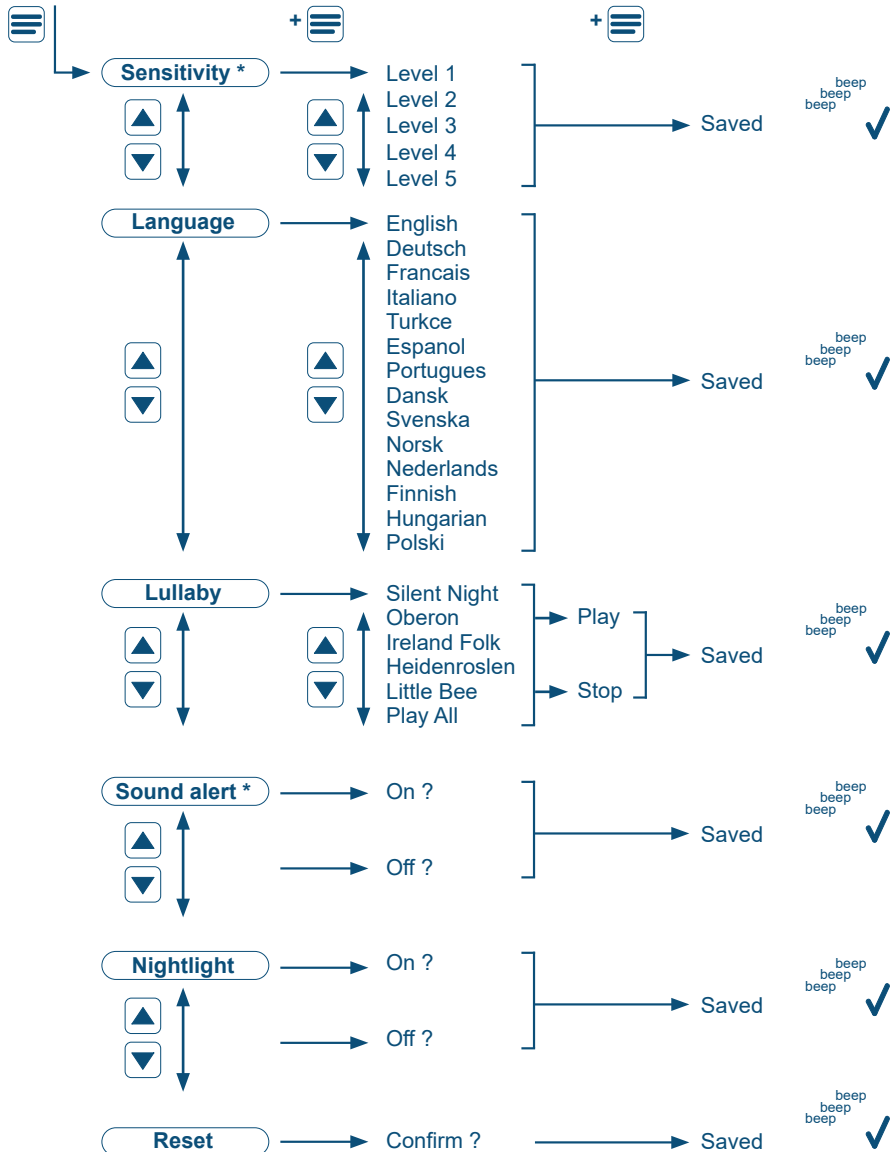

#### Sound alert

Ako beba pravi mnogo buke u trajanju od najmanje 3 sekunde, a roditeljska jedinica je prebačena na tišinu , uključice se svetlo na ekranu. U istom trenutku počecće da treperi i ikonica alarma  i roditeljska jedinica će početi da emituje ton.

15 Meni



### 13 Upotreba gumba

-  Gumb za izbornik/gumb za potvrdu (pogledajte također 15)
-  Gore u izborniku/Glasnoća + (pogledajte također 8)
-  Dolje u izborniku/Glasnoća - (pogledajte također 8)
-  Povratak na prethodni korak u izborniku
-  Uključivanje i isključivanje osnovnog uređaja (pogledajte također 4)  
Povratak na početni prikaz zaslona

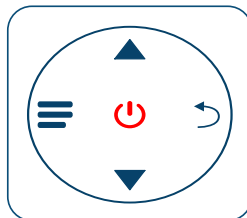



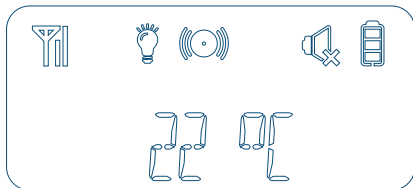





### 14 Početni zaslon osnovnog uređaja



HI TEMP = Upozorenje uređaja za bebu o temperaturi > 30 °C

LO TEMP = Upozorenje uređaja za bebu o temperaturi > 10 °C

- |   |   |   |
|---|---|---|
|  Nema veze s uređajem za bebu                      |  Omogućeno je zvučno upozorenje        |  Baterija je 2/3 puna      |
|  Dobra veza s uređajem za bebu                     |  Zvuk na osnovnom uređaju je isključen |  Baterija je 1/3 puna      |
|  Na uređaju za bebu omogućen je rad noćnog svjetla |  Baterija potpuno napunjena            |  Baterija je gotovo prazna |

### Objašnjenje u 15

#### Sensitivity

Potpuno ekološki način rada je aktivan kada beba spava i ne stvara zvukove. Uređaj za bebu će se tada prebaciti u mirovanje i predajnik će se isključiti kako više ne bi bilo prijenosa između uređaja za bebu i osnovnog uređaja.

Kada beba počne stvarati zvukove, predajnik će se opet aktivirati i moći ćete čuti bebu na osnovnom uređaju. Osjetljivost ove funkcije može se podesiti u 4 koraka s pomoću sljedećih ▲ ▼ gumba:

Korak 1 (najniža osjetljivost) do koraka 4 (najviše osjetljivost)

U koraku 4 puni se ekološki način rada isključuje radi kontinuirane veze.

#### Sound alert

Ako beba stvara puno jakih zvukova 3 uzastopne sekunde i zvuk osnovnog uređaja je utišan , zasvijetlit će svjetlo na zaslonu.





Istodobno će započeti treptati ikona za zvučno upozorenje () i osnovni uređaj će se oglasiti tonom.

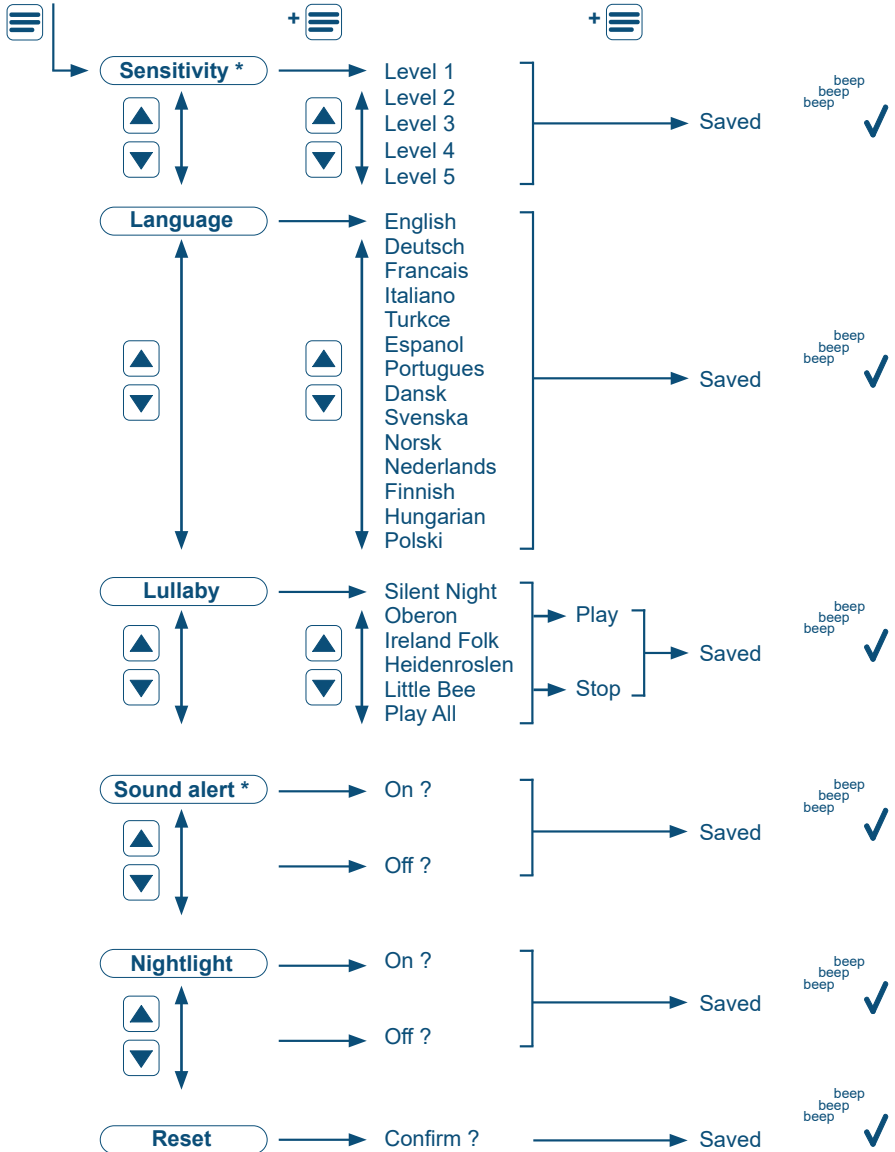

15 Izbornik



### 13 Tuşların çalışması

-  Menü düğmesi / Onaylama düğmesi (ayrıca bkz. 15)
-  Menüde yukarı çık / Ses + (ayrıca bkz. 8)
-  Menüde aşağı in / Ses - (ayrıca bkz. 8)
-  Menüde önceki adıma geri dön
-  Ana ünite açma ve kapama Ekran başlatma ekranına geri dön (ayrıca bkz. 4)

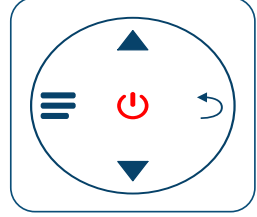



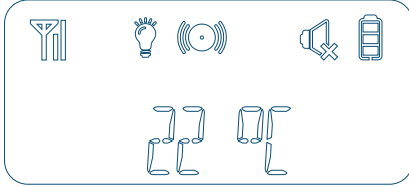





### 14 Ebeveyn ünitesi çalıştırma ekranı



YÜKSEK ISI = Bebek ünitesi ısı alarmı > 30 °C

DÜŞÜK ISI = Bebek ünitesi ısı alarmı < 10 °C

- |   |  |   |
|---|--|---|
|  Bebek ünitesiyle bağlantı kesildi               |  Ses alarmı etkinleştirildi     |  Pil 2/3 dolu        |
|  Bebek ünitesine bağlanıldı                      |  Ebeveyn ünitesinin sesi kapalı |  Pil 1/3 dolu        |
|  Bebek ünitesindeki gece lambası etkinleştirildi |  Pil tam dolu                   |  Pil hemen hemen boş |

### 15 ile ilgili açıklama

#### Hassaslık

Full Eco modu bebek uyurken veya herhangi bir ses çıkarmadığında devreye girer.

Bunun ardından bebek ünitesi bekleme moduna geçer ve bebek ünitesi ile ebeveyn ünitesi arasında daha fazla aktarım olmaması için verici kapanır.

Bebekten ses gelmeye başladığında, verici tekrar devreye girer ve ebeveyn ünitesi aracılığıyla bebeğinizin sesini duymaya başlardı. Bu fonksiyonun hassasiyeti ▲▼ tuşları kullanılarak 4 adımda ayarlanabilir:

Adım 1 (en düşük hassasiyet) - adım 4 (en yüksek hassasiyet).

Adım 4'te Full Eco modu kesintisiz bağlantı sağlamak üzere kapatılır.

#### Ses alarmı



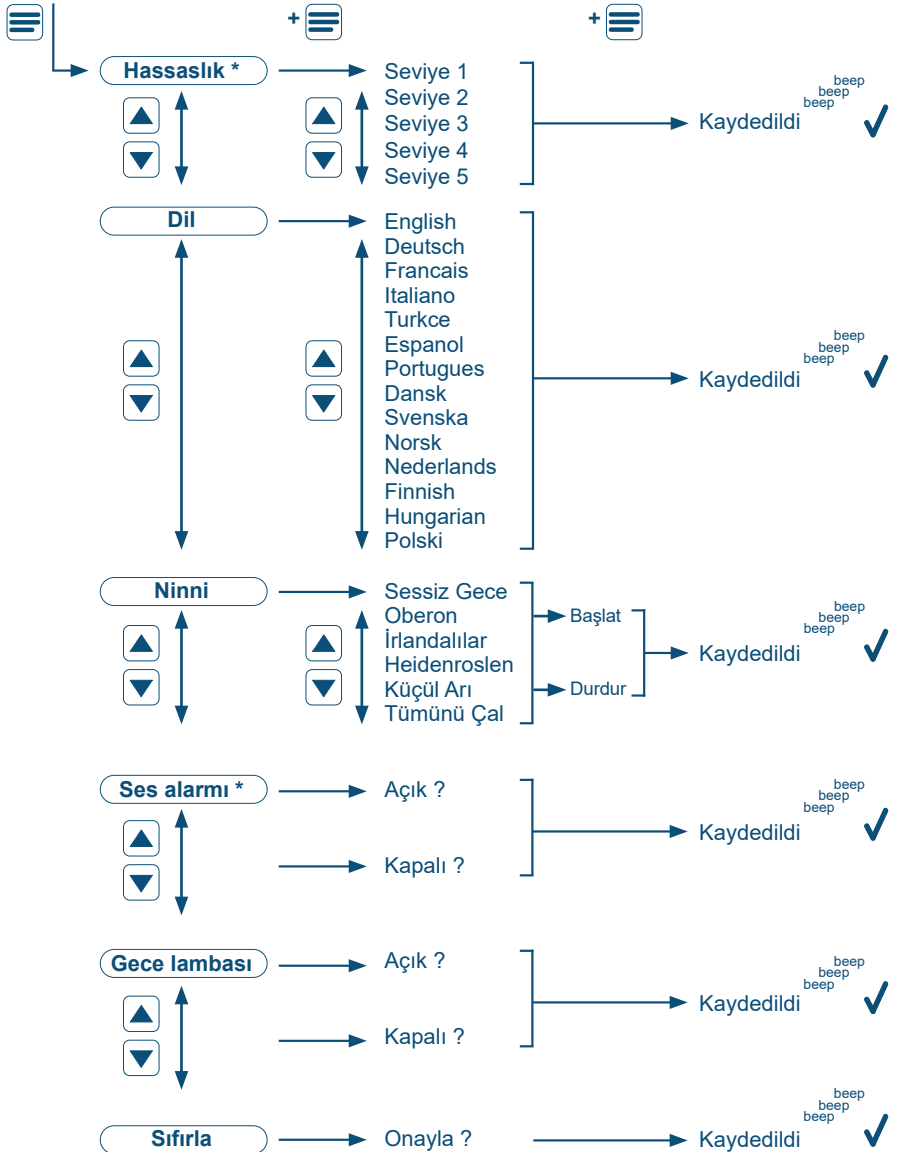

Bebekten arka arkaya en az 3 saniye çok fazla ses gelmesi ve ebeveyn ünitesinin sesinin sessiz  alınmış olması halinde, ekran ışığı yanar.

Aynı anda ses ses alarmı simgesi (●) yanıp sönmeye başlar ve ebeveyn ünitesinden ses gelir.

## 15 Menü



### 13 Бутони за работа

-  Бутон меню / Бутон потвърди (вж. и 15)
-  Нагоре в менюто / Звук + (вж. и 8)
-  Надолу в менюто / Звук - (вж. и 8)
-  Връщане към предишната стъпка в менюто
-  Основен модул вкл. и изкл. (вж. и 4)  
Обратно към началния екран на дисплея

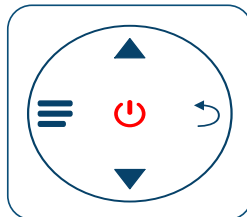



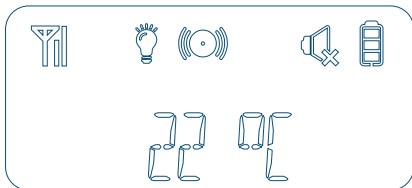





### 14 Начален екран на основен модул



HI TEMP = Аларма за температура > 30 °C на бебефона

LO TEMP = Аларма за температура < 10 °C на бебефона

- |   |  |  |
|---|--|--|
|  Няма връзка с бебефона          |  Вкл. аларма за звук              |  Батерията е 2/3 пълна    |
|  Добра връзка с бебефона         |  Звукът на основния модул е изкл. |  Батерията е 1/3 пълна    |
|  Вкл. нощна светлина на бебефона |  Батерията е заредена             |  Батерията е почти празна |



### Обяснения в 15

#### Sensitivity

Режимът Full Eco е активен, когато бебето спи и не издава звуци. Бебефонът ще се включи на режим „изчакване” и предавателят се изключва, за да се гарантира, че няма предаване на звуци между бебефона и основния модул. Когато бебето започне да издава звуци, предавателят се включва отново и ще можете да чувате бебето през основния модул. Чувствителността на тази функция може да се зададе в 4 стъпки чрез бутони ▲▼:

Стъпка 1 (най-ниска чувствителност) до стъпка 4 (най-висока чувствителност). На стъпка 4 се изключва режим Full Eco, за да се позволи непрекъснатата връзка.



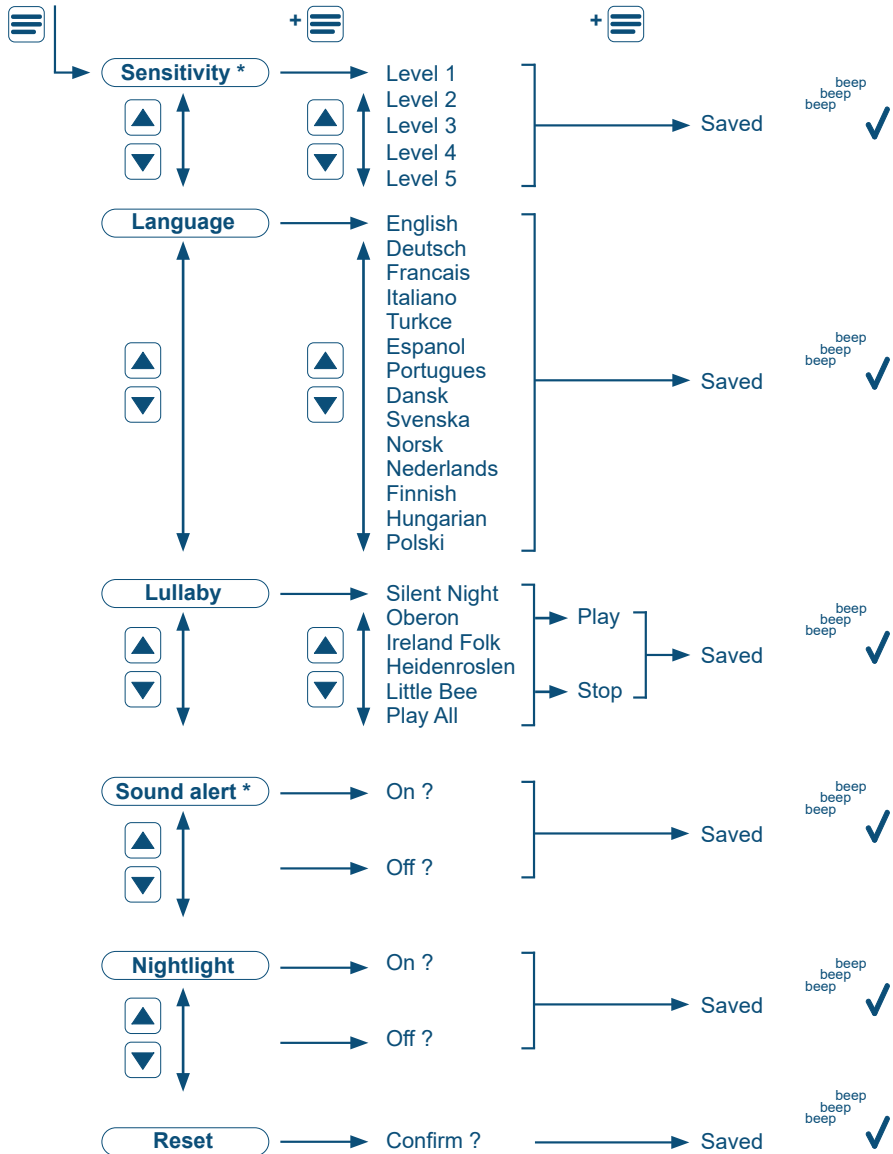

#### Sound alert

Ако бебето вдига много шум в продължение на поне 3 последователни секунди и звукът на основния модул е зададен на изкл. , светва лампичката на дисплея. В същото време иконата за аларма за звука () започва да присветва и основният модул издава звук.

15 Меню



### 13 Funkcie tlačidiel

-  Tlačidlo ponuky/tlačidlo na potvrdenie (pozri aj 15)
-  Nahor v ponuke/Hlasitosť + (pozri aj 8)
-  Nadol v ponuke/Hlasitosť - (pozri aj 8)
-  Návrat na predchádzajúci krok v ponuke
-  Zapnutie/vypnutie rodičovskej jednotky (pozri aj 4)  
Návrat na úvodnú obrazovku displeja

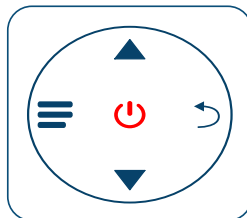

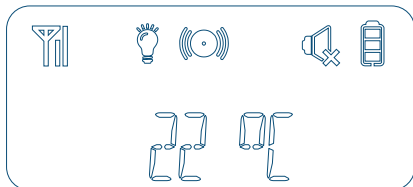

### 14 Úvodná obrazovka rodičovskej jednotky





HI TEMP = Upozornenie na teplotu detskej jednotky > 30 °C

LO TEMP = Upozornenie na teplotu detskej jednotky < 10 °C

 Žiadne spojenie s detskou jednotkou

 Zvuková výstraha je zapnutá

 Batéria je nabitá na 2/3

 Dobré spojenie s detskou jednotkou

 Zvuk na rodičovskej jednotke je vypnutý

 Batéria je nabitá na 1/3

 Na detskej jednotke je zapnuté nočné svetlo

 Batéria je úplne nabitá

 Batéria je takmer vybitá

### Vysvetlenie na 15

#### Sensitivity

Režim Full Eco je aktívny, keď dieťa spí a nevydáva žiadne zvuky.

Detská jednotka sa potom prepne do pohotovostného režimu a vysielateľ sa vypne, čím sa zaisťí, že medzi detskou jednotkou a rodičovskou jednotkou neprebíha žiadny prenos.

Keď dieťa začne vydávať zvuky, vysielateľ sa opäť zapne a budete počuť dieťa prostredníctvom rodičovskej jednotky. Citlivosť tejto funkcie môžete nastaviť v 4 krokoch pomocou tlačidiel ▲▼:

Od kroku 1 (najnižšia citlivosť) až po krok 4 (najvyššia citlivosť).

V kroku 4 sa vypne režim Full Eco, čím sa povolí nepretržité pripojenie.

#### Sound alert



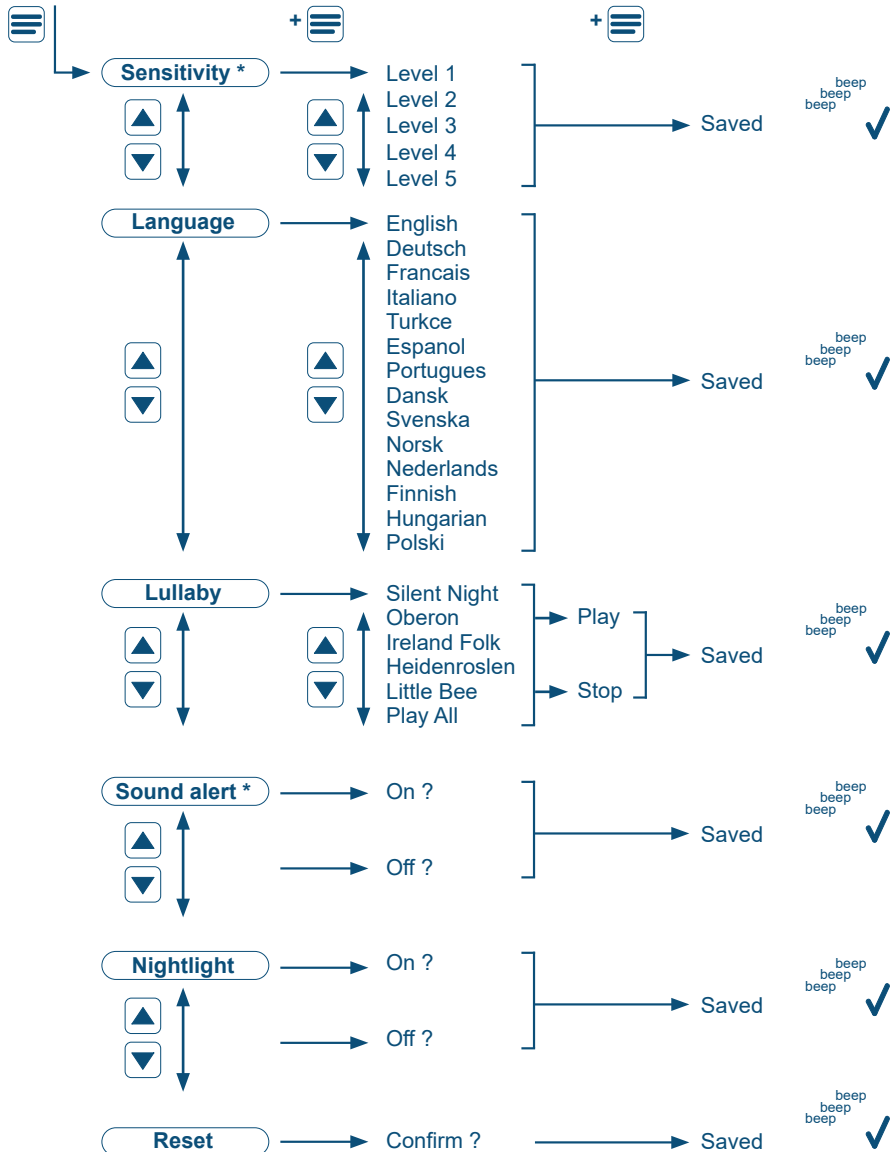

Ak dieťa vydáva intenzívny zvuk počas 3 po sebe nasledujúcich sekúnd a zvuk rodičovskej jednotky je stíšený , rozsvieti sa svetlo displeja.

Zároveň začne blikať ikona upozornenia na zvuk  a rodičovská jednotka bude vydávať tón.

15 Ponuka



### 13 Kezelőszervek

-  Menü gomb / Megerősítés gomb (ld. még: 15)
-  Menü fel / Hangerő + (ld. még: 8)
-  Menü le / Hangerő - (ld. még: 8)
-  Visszatérés az előző lépéshez a menüben
-  Szülő egység be / ki (ld. még: 4)  
Vissza a kijelző kezdőképernyőjéhez

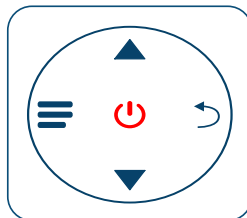

### 14 Szülő egység kezdőképernyő

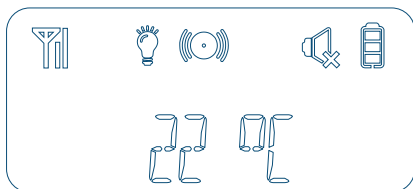

**MAGAS HŐM** = Baba egység hőmérséklet vészjelzés > 30 °C

**ALACSONY HŐM** = Baba egység hőmérséklet vészjelzés < 10 °C

- |  |   |   |
|--|---|---|
|  Nincs kapcsolat a baba egységgel           |  Hangriasztás engedélyezve               |  Akkutöltöttség: 2/3 |
|  Megfelelő kapcsolat a baba egységgel       |  Hangjelzés a szülő egységen kikapcsolva |  Akkutöltöttség: 1/3 |
|  Éjszakai fény engedélyezve a baba egységen |  Akku feltöltve                          |  Akku lemerül        |

## Magyarázat a 15 -höz

### Érzékenység

A Full Eco mód akkor aktiválódik, ha a baba alszik és csendben van.

Ekkor a baba egység készenléti állapotba kerül és a transzmitter kikapcsol annak érdekében, hogy ne legyen átvitel a baba és a szülő egység között.

Amint a baba hangokat ad, a transzmitter ismét bekapcsol és a baba hallható lesz a szülő egységen. E funkció érzékenysége 4 fokozatban állítható a ▲ ▼ gombokkal:

az 1. fokozattól (legalacsonyabb érzékenység) a 4. fokozatig (legmagasabb érzékenység).

A 4. fokozatnál a Full Eco mód kikapcsol a folyamatos kapcsolat biztosítása érdekében.

### Hangriasztás

Ha a baba legalább 3 másodpercen át folyamatosan sok hangot ad, és a szülő egység hangja némára  van állítva, akkor világitani kezd a kijelző.





Ezzel egyidejűleg a hangriasztás ikon  villogni kezd, és a szülő egység hangjelzést ad.

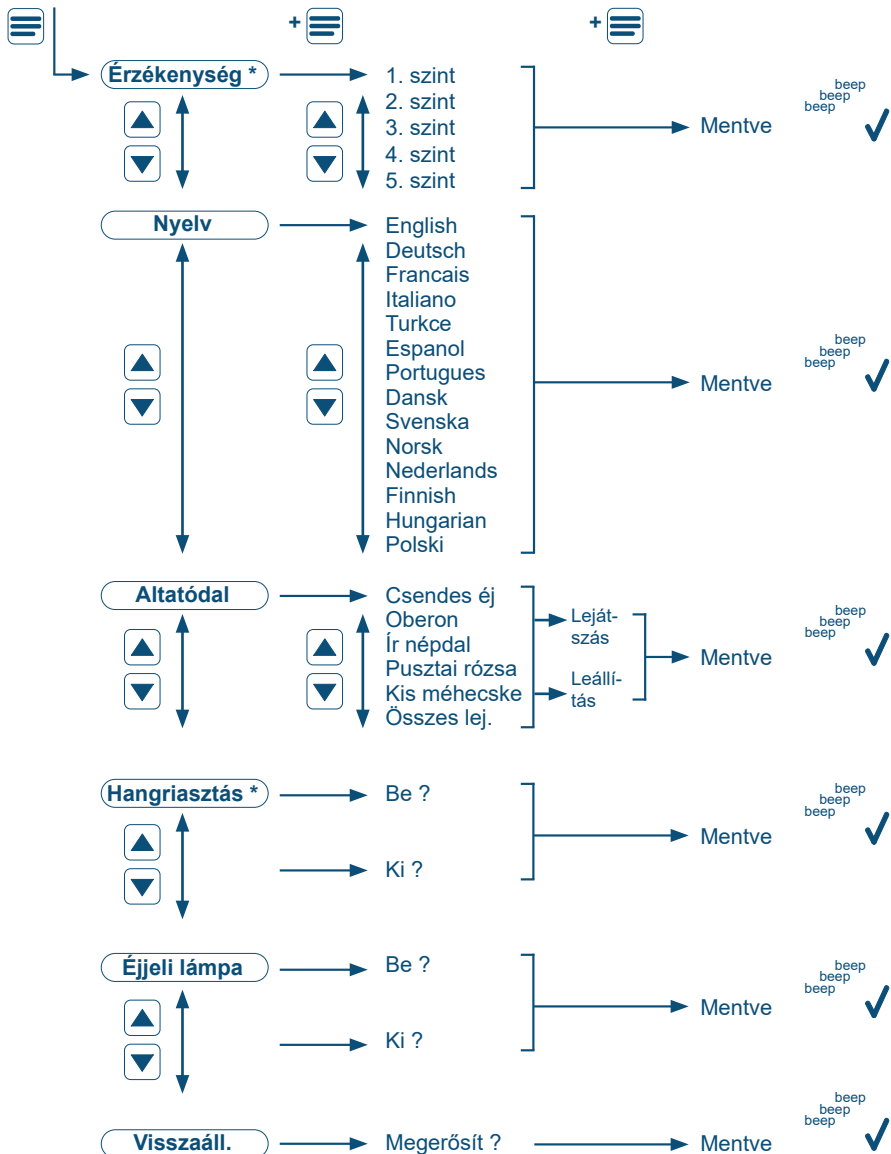

15 Menü



### 13 Nuppude toimingud

-  Menüü nupp / kinnitamise nupp (vaata ka 15)
-  Menüüs üles / helitugevus + (vaata ka 8)
-  Menüüs alla / helitugevus - (vaata ka 8)
-  Menüüs eelmise astme juurde tagasi liikumine
-  Vanemaseadme sisse ja välja tagasi kuvari avaekraanile (vaata ka 4)

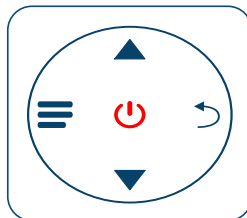

### 14 Vanemaseadme avaekraan

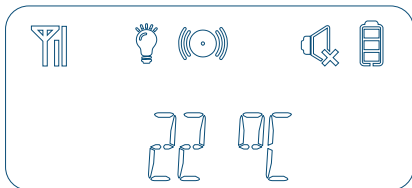

HI TEMP = Beebiseadme temperatuuri hoiatus  
> 30 °C

LO TEMP = Beebiseadme temperatuuri hoiatus  
< 10 °C

- |   |   |   |
|---|---|---|
|  Puudub ühendus beebiseadmega                |  Helisignaal on sisse lülitatud        |  Aku 2/3 täis        |
|  Hea ühendus beebiseadmega                   |  Heli on vanemaseadmel välja lülitatud |  Aku 1/3 täis        |
|  Öövalgustus on beebiseadmel sisse lülitatud |  Aku täielult laetud                   |  Aku on peaaegu täis |

### Selgitus on 15

#### Sensitivity

Täielik ökorežiim (Full Eco) aktiveerub kui beebi magab ja ei tee häält.

Beebiseade lülitub siis ooterežiimi ja saatja lülitatakse välja tagamaks, et beebi- ja vanemaseadme vahel enam ülekannet ei toimuks.

Kui beebi hakkab häält tegema, lülitatakse saatja uuesti sisse ja sa kuuled beebit läbi vanemaseadme.

Selle funktsiooni tundlikkust saab seadistada 4-astmelisena, kasutades selleks nuppe ▲▼:

aste 1 (madalaim tundlikkus) kuni aste 4 (kõrgeim tundlikkus).

4. astme juures lülitatakse täielik ökorežiim pideva ühenduse võimaldamiseks välja.

#### Sound alert



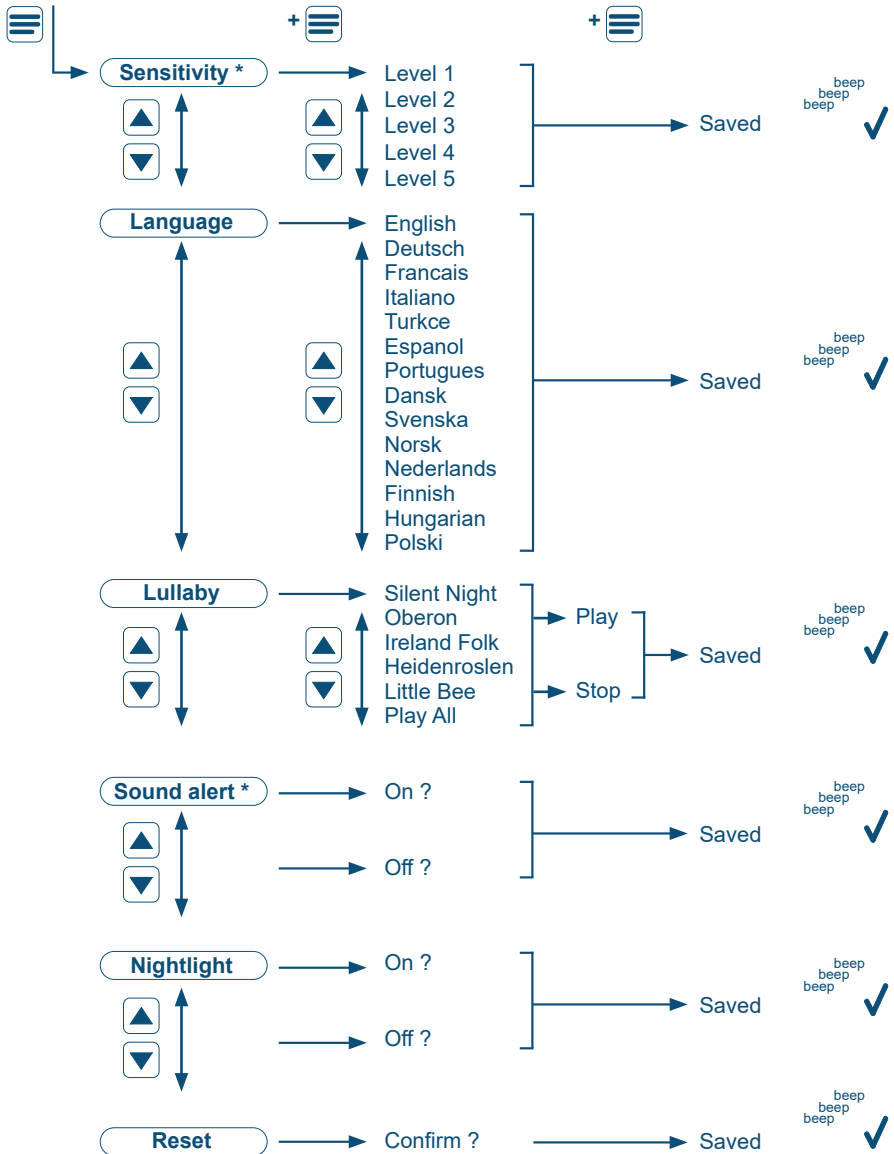

Kui beebi teeb palju müra vähemalt 3 järjestikusel sekundil ja vanemaseadmel on heli vaikse peale seatud (🔊), süttib kuvari valgustus.

Samal ajal hakkab vilkuma helisignaali ikoon (🔊) ja vanemaseade tekitab heli.

15 Menü



## 13 Taustiņi

-  Izvēlnes taustiņš / Apstiprināšanas taustiņš (skatīt arī 15 sadaļ)
-  Skaļāk izvēlne / Skaļums + (skatīt arī 8 sadaļ)
-  Klusāk izvēlne / Skaļums - (skatīt arī 8 sadaļ)
-  Atgriezties iepriekšējā solī izvēlnē
-  Vecāku ierīces ieslēgšana un izslēgšana  
Atpakaļ uz displeja sākuma ekrānu (skatīt arī 4 sadaļ)

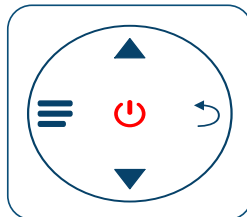



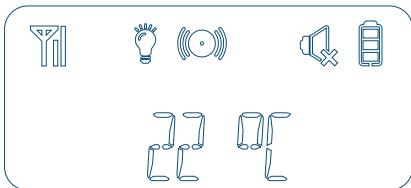





## 14 Vecāku ierīces sākuma ekrāns



HI TEMP = Mazuļa ierīces temperatūras  
brīdinājums > 30 °C

LO TEMP = Mazuļa ierīces temperatūras  
brīdinājums < 10 °C

- |  |   |  |
|--|---|--|
|  Nav savienojuma ar<br>mazuļa ierīci              |  Skaņas signāla brīdi-<br>nājums ir ieslēgts |  Baterija 2/3 pilna           |
|  Labs savienojums ar<br>mazuļa ierīci             |  Skaņa vecāku ierīcei<br>ir izslēgta         |  Baterija 1/3 pilna           |
|  Nakts apgaismojums ir<br>ieslēgts mazuļa ierīcei |  Baterija ir pilnībā<br>uzlādēta             |  Baterija ir gandrīz<br>tukša |

## Skaidrojums par 15 sadaļu

## Sensitivity

Pilnīgi ekonomiskais režīms ir aktīvs, kamēr mazulis guļ un neizdveš nekādas skaņas. Tad mazuļa ierīce pārslēgsies gaidīšanas režīmā un raidītājs tiks izslēgts, lai notiktu vairs pārsūtīšana starp mazuļa ierīci un vecāku ierīci.

Kad mazulis sāk izdot skaņas, raidītājs tiek atkal ieslēgts un jūs varēsiet dzirdēt savu mazuli vecāku ierīcē. Šīs funkcijas jutīgumu var iestatīt 4 soļos ar ▲ ▼ taustiņiem:

1. solis (zemākais jutīgums) līdz 4. Solis (augstākais jutīgums).

4. solī pilnībā ekonomiskais režīms tiek izslēgts, lai varētu izveidot pastāvīgu savienojumus.

## Sound alert



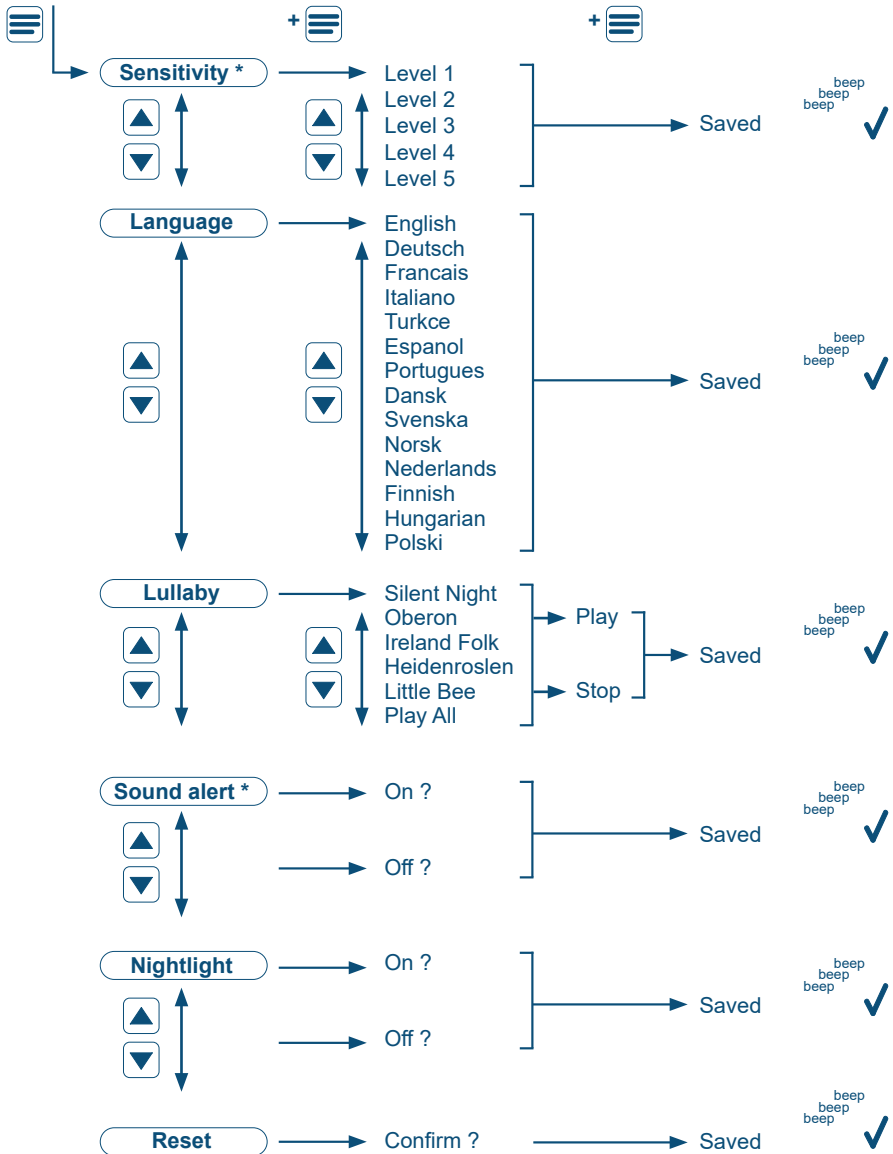

Ja mazulis izdveš daudz skaņas vismaz 3 sekunžu garumā un vecāku ierīce ir izslēgta skaņa , izgaismosies ierīces displejs.

Tajā pašā laikā sāks mirgot arī skaņas brīdinājuma ikona (●) un vecāku ierīce izdos skaņas signālu.

15 Izvēlne



### 13 Tipko za vklop in izklop

-  Tipka za meni/potrditev (poglejte tudi 15)
-  Navzgor v meniju/Glasnost + (poglejte tudi 8)
-  Navzdol v meniju/Glasnost - (poglejte tudi 8)
-  Vrnite se na prejšnji ukaz v meniju
-  Matična plošča vključena/izklopljena Nazaj na začetni zaslon (poglejte tudi 4)

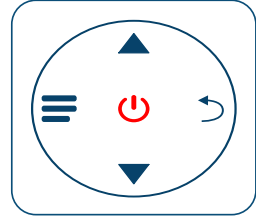



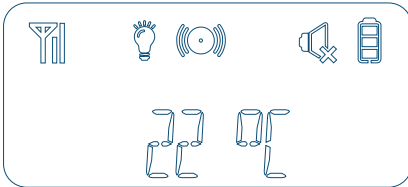





### 14 Zaslon za zagon matične plošče



HI TEMP = Opozorilo na enoti za temperaturo prostora > 30 °C

LO TEMP = Opozorilo na enoti za temperaturo prostora < 10 °C

- |   |  |   |
|---|--|---|
|  Ni povezave z otroško enoto             |  Opozorilo za nastavev glasnosti je omogočeno |  Baterija je 2/3 polna     |
|  Dobra povezava z otroško enoto          |  Zvok matične plošče je izklopljen            |  Baterija je 1/3 polna     |
|  Na otroški enoti je omogočena nočna luč |  Baterija je popolnoma napolnjena             |  Baterija je skoraj prazna |

## Razlaga na točki 15

### Sensitivity

Poln eko način je aktiven, ko dojenček spi in ne povzroča nobenih zvokov

Enota za dojenčka se nato preklopi v stanje pripravljenosti in oddajnik se izklopi, da se zagotovi, da ni več prenosa med otroško enoto in matično enoto.

Ko dojenček začne proizvajati zvok, je oddajnik znova omogočen in otroka lahko slišite preko matične enote. Občutljivost te funkcije je lahko nastavljena v štirih korakih ▲ ▼ z uporabo naslednjih tipk Stopnja 1 (najnižja občutljivost) do stopnje 4 (najvišja občutljivost).

V 4. Stopnji je način Full Eco izklopljen, kar omogoča neprekinjeno povezavo.

### Sound alert



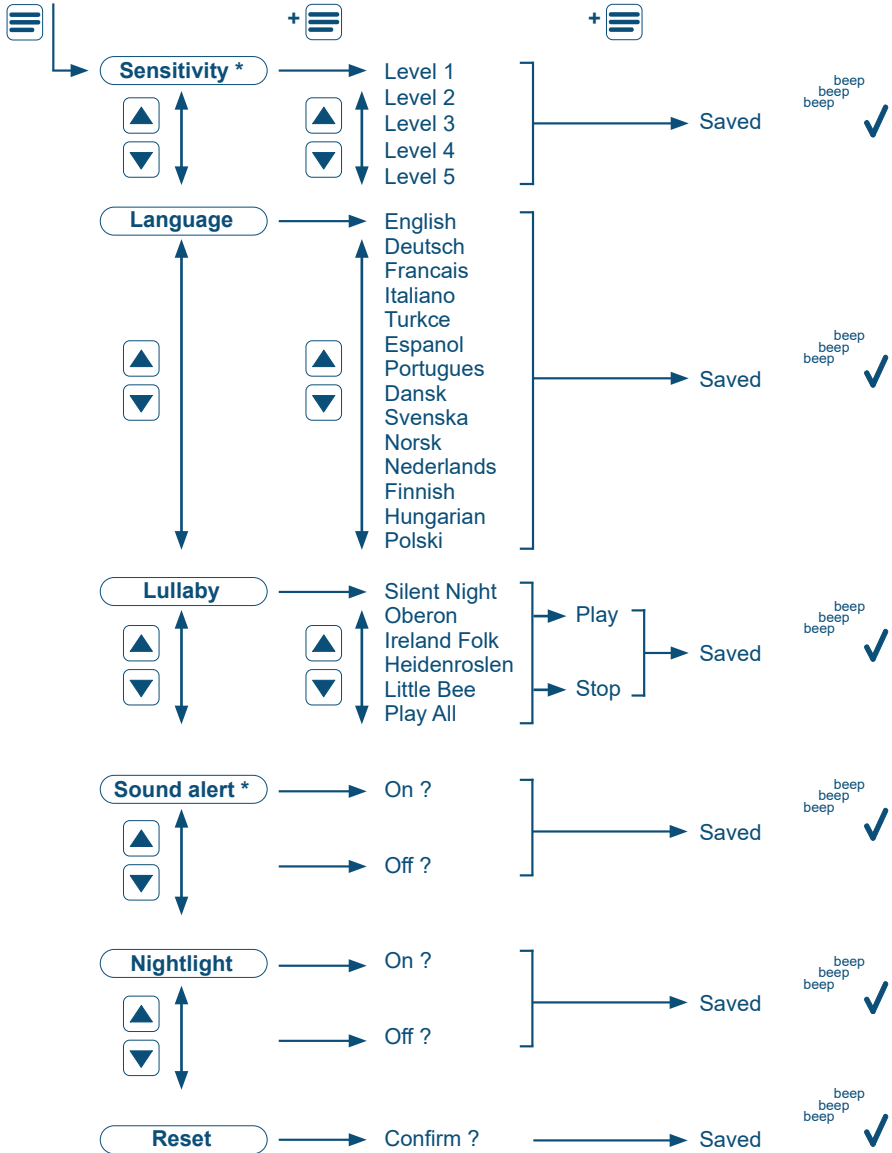

Če otrok joka ali kriči neprenehoma vsaj 3 sekunde in je  zvok na matični plošči utišan, na zaslonu zasveti lučka.

Istočasno se p opavi opozorilna ikona in matična plošča  odda zvočni signal.

15 Meni



### 13 Кнопки керування

-  Кнопка меню / підтвердження (див. також 15)
-  Вгору по меню / збільш. гучності (див. також 8)
-  Вниз по меню / зменш. гучності (див. також 8)
-  Повернення до попереднього пункту меню
-  Увімкнення й вимкнення батьківського блоку (див. також 4)  
Повернення до початкового екрана

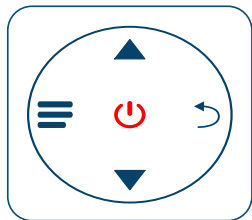



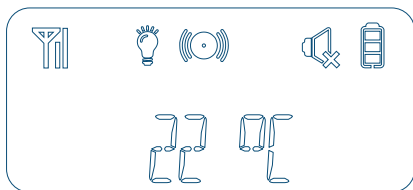





### 14 Початковий екран батьківського блоку



HI TEMP = Сигналізація температури дитячого блоку > 30 °C

LO TEMP = Сигналізація температури дитячого блоку < 10 °C

- |  |  |  |
|--|--|--|
|  Нема зв'язку з дитячим блоком      |  Звукову сигналізацію ввімкнено                       |  Батарейка заряджена на 2/3 |
|  Зв'язок із дитячим блоком хороший  |  Звукову сигналізацію на батьківському блоці вимкнено |  Батарейка заряджена на 1/3 |
|  На дитячому блоці ввімкнено нічний |  Батарейка заряджена повністю                         |  Батарейка майже розряджена |

### Пояснення до п. 15

#### Sensitivity

Режим повної економії діє, коли дитина спить і не подає жодних звуків. Тоді дитячий блок переходить у режим очікування, а передавач вимикається, внаслідок чого обмін даними між дитячим блоком і батьківським блоком повністю припиняється. Коли дитина починає подавати якісь звуки, передавач знову вмикається, і з батьківського блоку можна чути дитину. Ця функція має 4 рівні чутливості, яку можна налаштувати за допомогою кнопок ▲▼: рівень 1 відповідає найнижчій чутливості, а рівень 4 — найвищій. Якщо встановлено 4-й рівень чутливості, то режим повної економії не використовується, і з'єднання дитячого й батьківського блоків не переривається.

#### Sound alert

Якщо дитина сильно шумить принаймні 3 секунди поспіль, а звук у батьківському блоці вимкнено (🔇), то на ньому починає світитися екран. У той самий час починає блимати значок сигналізації звуку (🔊), і батьківський блок подає звуковий сигнал.



15 Меню

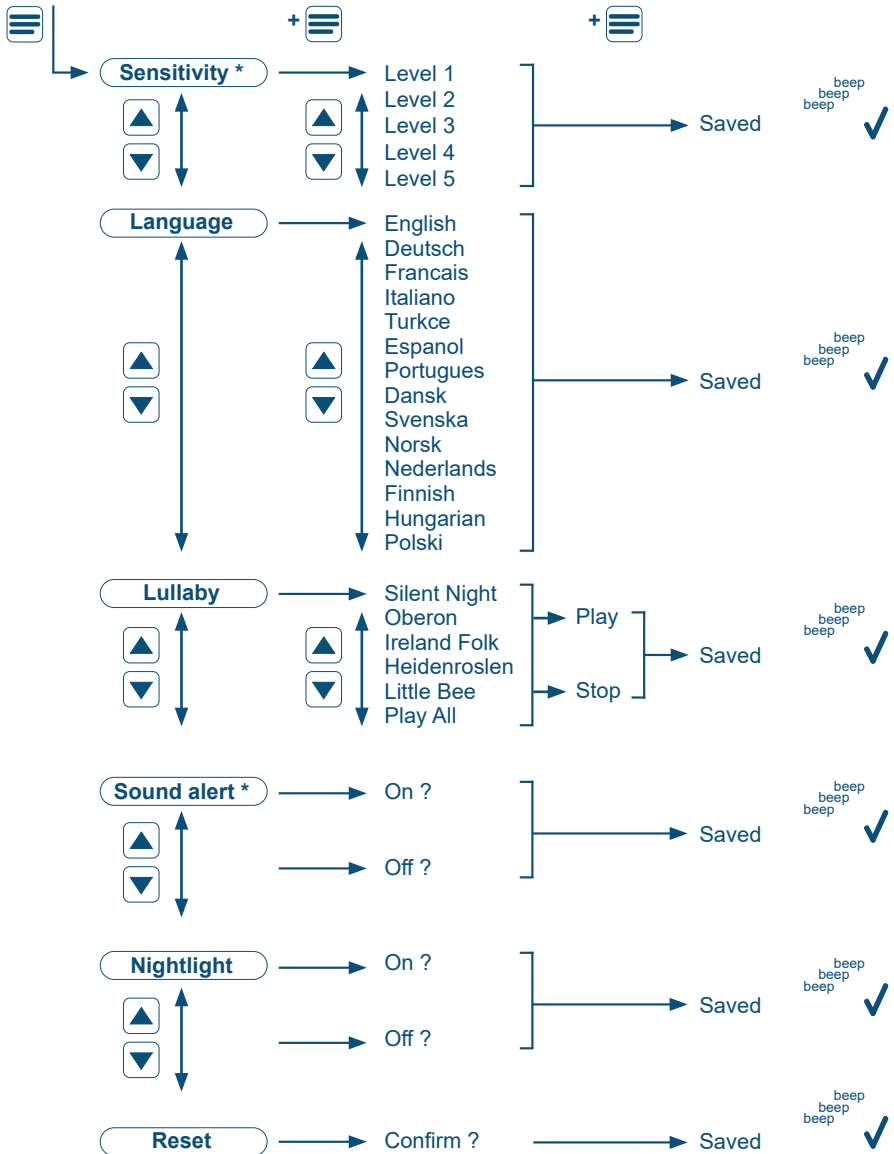





Commaxx B.V.  
Wiebachstraat 37  
6466 NG Kerkrade  
The Netherlands

[www.alectobaby.com](http://www.alectobaby.com)

#### Information Power Adapter:

Manufacturers name and address : Vtech Telecommunications LTD, 23/F., Tai Ping Industrial Centre, Block 1, 57 Ting Kok Road, Tai Po, Hong Kong.

Model Identifier :	S003ATV0600045
Input voltage :	100-240VAC
Input AC frequency :	50/60 Hz
Output voltage :	6.0V DC
Output current :	0.45 A
Output Power :	2.7 W
Average active efficiency :	74.9 %
Efficiency at low 10% load :	-
No load Power consumption :	0.03 W

- \* Use only rechargeable NiMH battery listed below:
- 1) GPI, VTRHC043C033 (Designation No.: xx40AAAHC)
  - 2) CORUN, Ni-MHAAA400 (Designation No.: Ni-MH AAA 400mAh 1.2V)
- Caution: Risk of explosion if battery is replaced by an incorrect type!  
Dispose of used batteries according to the instructions.

- \*\* For pluggable equipment, the socket-outlet shall be installed near the equipment and shall be easily accessible.

Frequency Range : 1880-1900 Mhz  
Maximum Power : < 24 dBm

For Indoor use only

#### DECLARATION OF CONFORMITY

Hereby, Commaxx declares that the radio equipment type Alecto DBX120 is in compliance with directive 2014/53/EU.

The full text of the EU declaration of conformity is available at the following internet address: <http://DOC.hesdo.com/DBX120-DOC.pdf>

